



Product guide

2019/2020 EN

R82[®] 



More than 30 years at eye level

R82 produces technical aids and appliances for disabled children and young people throughout the world. Based in Denmark with sales companies in England, Holland, Italy, Germany, Australia and the USA, we develop products tailored to individual needs.

Through comprehensive development R82 is constantly moving forward- but without compromising quality of service and closeness to the customer. Distributors in 45 countries spread over most of the globe ensure forward personal support, even after the product has been delivered.

The objective of each and every R82 employee is: adjustment to individual needs to provide the child the greatest possible freedom - in a world of movement.



SEATING

| | |
|-----------------------|-----|
| Kudu..... | 7 |
| Cougar..... | 13 |
| x:panda..... | 19 |
| Panda Futura..... | 25 |
| Panda Futura 5..... | 31 |
| Scallop..... | 37 |
| Wombat Living..... | 41 |
| Cricket..... | 47 |
| Stingray..... | 53 |
| Cruiser..... | 59 |
| EZ Rider..... | 65 |
| Rodeo..... | 71 |
| High-low Frame..... | 77 |
| High-low:x Frame..... | 81 |
| Multi Frame..... | 87 |
| Multi Frame:x..... | 93 |
| Stingray Frame..... | 99 |
| Combi Frame:x..... | 103 |
| Strong Base..... | 109 |



STANDING

| | |
|-----------------|-----|
| Meerkat..... | 115 |
| Rabbit Up..... | 121 |
| Toucan..... | 127 |
| Caribou..... | 133 |
| Gazelle PS..... | 139 |



WALKING

| | |
|----------------|-----|
| Mustang..... | 145 |
| Crocodile..... | 151 |
| Pony..... | 157 |



TRANSPORTATION

| | |
|-------------------------|-----|
| Stingray Swing-out..... | 165 |
|-------------------------|-----|



TOILET & BATH

| | |
|------------------------|-----|
| Flamingo High-low..... | 171 |
| Flamingo..... | 177 |
| Heron..... | 183 |
| Swan..... | 189 |
| Manatee..... | 195 |
| Orca Penguin..... | 201 |



ACCESSORIES

| | |
|----------------------|-----|
| Head Supports..... | 209 |
| Side Supports..... | 213 |
| Vests and belts..... | 217 |
| Trays..... | 221 |



Hi and welcome
to the R82 catalogue
for 2019/2020. I hope
you like it...



Seating, overview

Seating systems

(Wheelchairs, working chairs, floor seats)

| | | Kudu | Cougar | Scallop | Wombat Living |
|--------------|---|-------------|--------------|-------------|---------------|
| Target users | Max. load | 60 kg | 100 kg | 70 kg | 70 kg |
| | Max. load for transportation | 57 kg | 75 kg | - | - |
| | User height | 850-1700 mm | 1300-1700 mm | 600-1400 mm | 750-1900 mm |
| Features | Self centering seat plane angle adjustment/Back recline | • | • | | |
| | Safe transportation in vehicles | • | • | | |
| | Back recline | • | • | | • |
| | Seat plane angle adjustment | • | • | | • |
| | Easy Fold - Light weight | | | • | |
| Environment | Indoor | • | • | • | • |
| | Outdoor | • | • | • | |

Seating systems

(Buggies)

| | | Cricket | Stingray | Cruiser | EZ Rider | Rodeo |
|--------------|---------------------------------|-------------|-------------|-------------|--------------|-------------|
| Target users | Max. load | 50 kg | 40 kg | 113 kg | 77 kg | 63 kg |
| | Max. load for transportation | 43 kg | 40 kg | 113 kg | 77 kg | 63 kg |
| | User height | 850-1400 mm | 750-1500 mm | 600-1800 mm | 1000-1800 mm | 700-1700 mm |
| Features | Safe transportation in vehicles | • | • | • | • | • |
| | Back recline | • | • | | | • |
| | Seat plane angle adjustment | | • | | | • |
| | Easy Fold - Light weight | • | | • | • | • |
| | 180° turnable seat | | • | | | |
| Environment | Indoor | • | • | • | • | • |
| | Outdoor | • | • | • | • | • |

Seats

| | | | x:panda | Panda Futura | Panda Futura 5 |
|--------------|------------------------------------|--|-------------|--------------|----------------|
| Target users | Max. load | | 80 kg | 60 kg | 85 kg |
| | Max. load for transportation | | 75 kg | 57 kg | 85 kg |
| | User height | | 650-1800 mm | 1000-1400 mm | 1600 mm |
| Features | Dynamic back | | • | | |
| | Growth (width, depth, back height) | | • | | |
| | Back recline (backrest angle) | | -5°-30° | •* | -5°-30° |
| | Fits on a variety of frames | | • | • | • |
| Environment | Indoor | | • | • | • |
| | Outdoor | | • | • | • |

Frames

| | | High-low & High-low:x | Multi Frame | Multi Frame:x | Stingray Frame | Combi Frame:x | Strong Base |
|--------------|--|-----------------------|-------------|---------------|----------------|---------------|-------------|
| Target users | Max. load | 60-100 kg | 100 kg | 100 kg | 40 kg | 100 kg | 120 kg |
| | Max. load for transportation | 60 kg* | 100 kg | 100 kg | 40 kg | 100 kg | - |
| Features | Height adjustment (manual, gas, hydraulic, spindle or power) | • | | | | | • |
| | Seat plane angle adjustment | • | • | • | • | • | • |
| | 180° turnable seat unit | | | | • | | |
| Environment | Indoor | • | • | • | • | • | • |
| | Outdoor | •* | • | • | • | • | • |
| | Overall width | 560-620 mm | 590-690 mm | 660 mm | 590 mm | 580-730 mm | 600 mm |

*Depends on model



Seating

Comfortable seating systems giving the greatest possible support and mobility!



User height
850–1700 mm



Max. load
60 kg



Environment
Indoor & outdoor

Kudu[®]

The Kudu is a practical wheelchair which combines form and function to provide the right fit and support for a comfortable posture.

The Kudu is available in 4 sizes.

Highlights about Kudu



Growth adaptable

The base of the seat and the back rest are equipped with a mechanism that makes it possible to adjust height and depth as well as mount fix-locks for vests and belts.



Accessories are easily added and removed as needed for maximum user comfort



Centre of gravity

To adapt to different needs, the seat has a centre of gravity making it possible to adjust the rear wheels in 3 different positions.



Safe transportation

The Kudu complies with ISO 7171-19 for transporting children up to 57 kg in motor vehicles.



Standard

Swing-away anti tip device, tilt in space, back angling (recline).

Options

- Size**
 - Size 1
 - Size 2
 - Size 3
 - Size 4
- Cushions**
 - Kudu cushions, upcharge
 - No cushions
 - Cushions with contour, upcharge
- For the hands**
 - Push brace, angle adjustable
 - Push brace, height and angle adjustable
 - Push handles, height adjustables
- Foot support**
 - Foot plate, centrally mounted
 - Parted foot rests (available for size 2+3+4)
- Rear wheels**
 - 12½"/16" solid or air
 - 20"/22"/24" solid or air with quick release
- Front wheels**
 - 6" solid front wheels
 - 7" solid or air front wheels
- Brakes**
 - Wheel brakes (available for 20", 22" and 24")
 - Drum brakes
- Anti-tips & spoke protectors**
 - Anti-tips
 - Spoke protectors

Frame colour



Anthracite grey



White



Red















Kudu with Push brace, angle adjustable



Kudu with Push handles, height adjustable

Measurements

| | | 1 | 2 | 3 | 4 |
|---|-----------------------------------|------------|------------|------------|------------|
|  | Effective seat width | 260 mm | 300 mm | 340 mm | 380 mm |
|  | Effective seat depth | 220-320 mm | 270-370 mm | 310-410 mm | 350-450 mm |
|  | Backrest height | 370-460 mm | 400-520 mm | 430-580 mm | 430-630 mm |
|  | Seat surface height at front edge | 480 mm | 480 mm | 480 mm | 480 mm |
|  | Max. load | 40 kg | 50 kg | 60 kg | 60 kg |
|  | Max. load at transportation | 40 kg | 50 kg | 57 kg | 57 kg |
|  | Backrest angle | -5° - 30° | -5° - 30° | -5° - 30° | -5° - 30° |
|  | Seat plane angle | -3° - 45° | -3° - 45° | -3° - 45° | -3° - 45° |
|  | Length | 690 mm | 690 mm | 740 mm | 740 mm |
|  | Overall width | 590 mm | 630 mm | 670 mm | 710 mm |
|  | Folded length | 825 mm | 825 mm | 875 mm | 875 mm |
|  | Folded width | 610 mm | 650 mm | 690 mm | 730 mm |
|  | Folded height | 625 mm | 625 mm | 625 mm | 625 mm |
|  | Total mass | 19 kg | 21 kg | 23 kg | 25 kg |

Further measurements at our website

The Kudu is measured with the following wheel combination, placed in the standard wheel position: 22" rear wheel and 6" front wheel.

Nice to know

The many different configuration possibilities and accessories to the kudu makes it ideal to situations where complex and individualized seating solutions is needed and reusing of the product is desirable. Examples of individualized solutions is placing the centrally mounted foot plate underneath the seat or using the angle adjustable armrest and tray allowing the tray to be horizontally when the seat plate is angled.

The focus of the seating solution will often be comfort, however when configured with large driving wheel and cambering it is possible to promote self-propelling of the wheelchair over short distances to support user independence.



Accessories

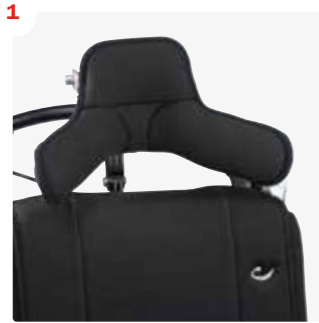

1
Head support
99xxxx-xx



2
Back extension cushion
95743-xxx



3
Fixed side supports
95401-xx



4
Swing-away side supports
8310xx-xxx



5
Back wedges
E6301x-60



6
Arm rests/Tray
95712-x/9576351
Padding
95712-x



7
Hip supports
95713-x0



8
Pommel
95430-x0
Padding
95430-x0260



9
Vest
89113-x



10
Mud guards
9520xx



11
Transport fittings
95900-10

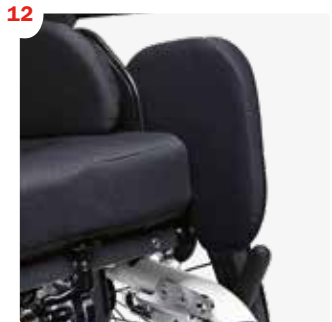

12
Adductors
95429-10

For more accessories - visit our website



Vent tray
95281-10



Pommel
95430-x



Upper arm supports
8910407-x0



Angle adjustable arm rests, incl. side plates
95712-x0



Canopy
87401x0
(Requires 9589100)

Karoline, 4 years old

"I am beautiful, clever and lovely"



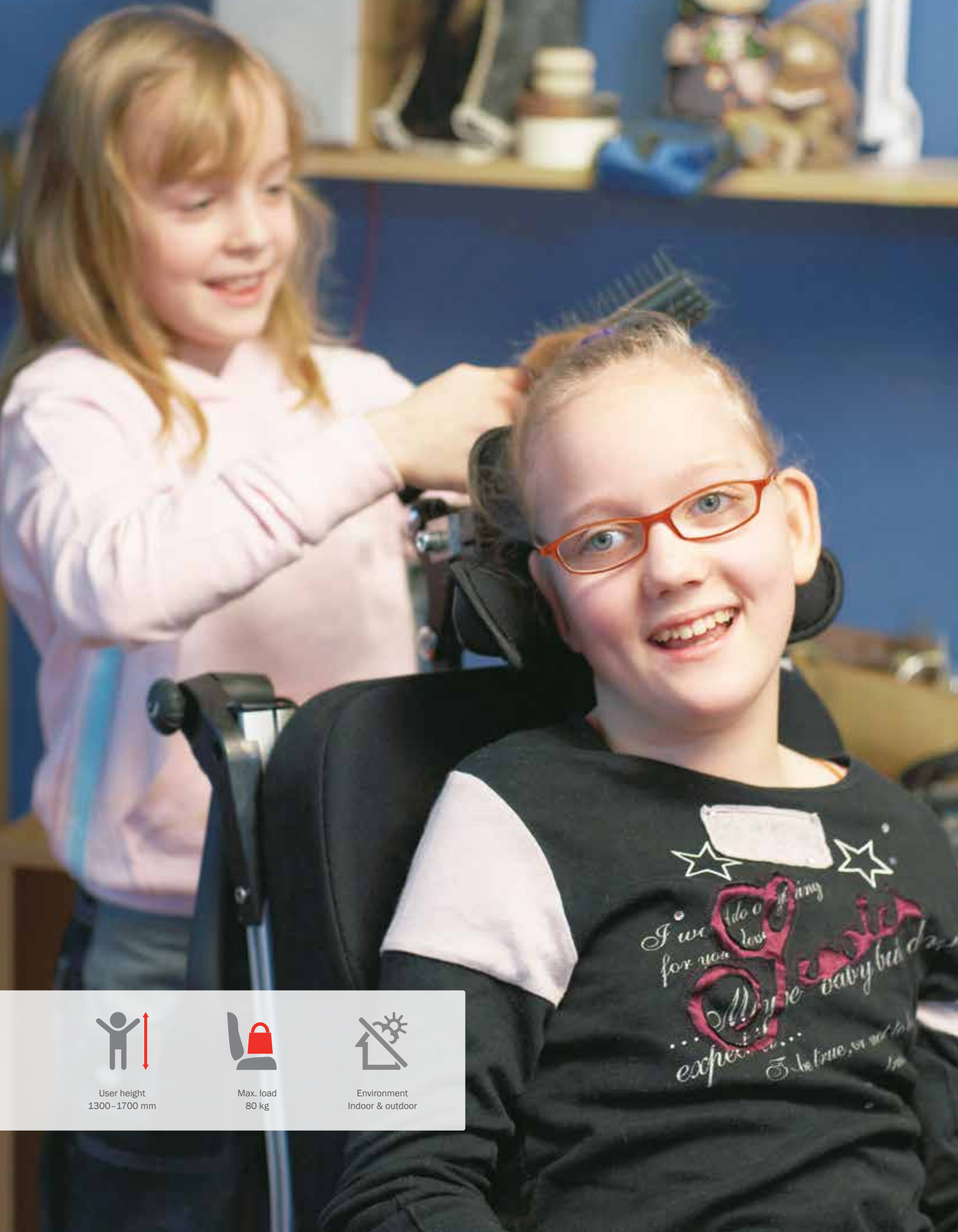

User height
1300-1700 mm



Max. load
80 kg



Environment
Indoor & outdoor

Cougar[®]

The Cougar is built for rehabilitation with comfort provided as standard and it has many adjustment possibilities and wide range of accessories.

The Cougar is available in 4 sizes for use by children and teenagers.

Highlights about Cougar



Back recline

The adjustment of the back tilt occurs in the anatomical pivot point of the hip and therefore with minimal shear.



Tilt in space

The Cougar has self-centering centre of gravity making it a stable comfortable chair. The tilt in space function gives the option of changing the users position and reduces pressure in the seating area.



Height adjustable

The seat to floor height is adjustable. Adjust the height on the back of the chair and the angle of the front wheels will remain in the correct position.



Accessories

Easily interchangeable for user comfort.



Standard

Patented change of seat to floor height, prepared for other manufactures seats and backs, easy change of seat depth, selfcentring centre of gravity, patented recline to ensures a minimum of shear, anti-tip safety.

Cushion colours



Black

Frame colour



Silver

Options

Four sizes

- Size 1
- Size 2
- Size 3
- Size 4

Rear wheels

- 12½" solid or air
- 20" solid or air
- 22" solid or air
- 24" solid or air

Brakes

- Wheel brake (not available for 12½")
- Drum brake

Front wheels

- 6" solid or air
- 8" solid or air (not in combination with 20" rear wheels)

Leg rests

- No leg rests
- Parted leg rests (length adjustable) with gas spring
- Parted leg rests, fixed

Calf support

- No calf support
- With calf support

Seat

- Wooden seat, no cushion
- Seat cushion, contoured
- No seat cushion and no wooden seat board

Back rest

- Strap back without cushion
- Strap back with thin cushion
- Strap back with contoured cushion
- Wooden back without cushion
- Wooden back with thin cushion
- Wooden back with contoured cushion

Back recline

- No recline
- Recline

Recline

- Operated from push brace or on side back
- User operated back adjustment
- User operated













Standard Cougar mounted with drum brake and wheel brakes.



Standard Cougar mounted with drum brake, wheel brakes and cushions.

Measurements

| | | 1 | 2 | 3 | 4 |
|---|-----------------------------------|--------------|--------------|--------------|--------------|
|  | Effective seat width | 350 mm | 400 mm | 450 mm | 500 mm |
|  | Effective seat depth | 350 - 450 mm | 370 - 470 mm | 430 - 530 mm | 490 - 590 mm |
|  | Backrest height | 450 mm | 500 mm | 600 mm | 600 mm |
|  | Seat surface height at front edge | 460 - 530 mm | 460 - 530 mm | 460 - 530 mm | 460 - 530 mm |
|  | Max. load | 75 kg | 75 kg | 100 kg | 120 kg |
|  | Max. load at transportation | 75 kg | 75 kg | 100 kg | 120 kg |
|  | Backrest angle | 37° | 37° | 37° | 37° |
|  | Seat plane angle | 90° | 90° | 90° | 90° |
|  | Length | 780 mm | 780 mm | 830 mm | 830 mm |
|  | Overall width | 570 mm | 620 mm | 670 mm | 720 mm |
|  | Folded length | 780 mm | 780 mm | 830 mm | 830 mm |
|  | Folded width | 570 mm | 620 mm | 670 mm | 720 mm |
|  | Folded height | 960 mm | 990 mm | 1080 mm | 1100 mm |
|  | Total mass | 25 kg | 26 kg | 27 kg | 28 kg |

Further measurements at our website

The Cougar is measured with cushion and the following wheel combination, placed in the standard wheel position: 22" rear wheel and 6" front wheel. The Cougar is measured with the seat in horizontal and back in vertical position. We supply various types of leg rests and cushions, which is why the weight is listed without. Different settings may result in another set of measurements.

Nice to know

Cougar can be fitted with a wooden board back or a strap back. Both backs are prepared for velcro fit cushion systems. Furthermore, the Cougar is often used for other seats and backs, such as moulded seats.

The stepless adjustment of the vertical position of the side supports allows a precise position of the supports in relation to the need of the individual user.



Accessories



Head supports
99xxxx-xx



Back extension, fixed
970055-x13

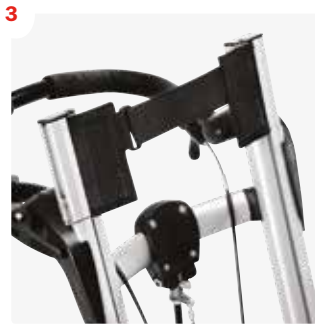

Back extension
970050-x13



Pommel
95430-x



Swing away sidesupport
83xxx-xxx



Arm rest/Extension
970600-x/970630-1

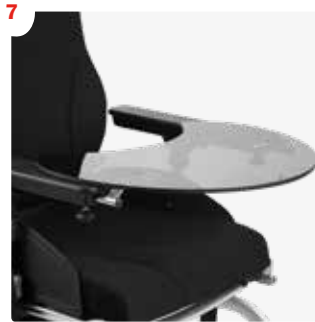

Tray
970240-x



Hip-belt
89661-4P

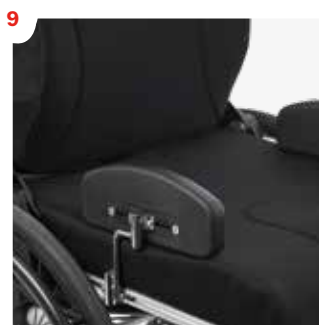

Hip support
970751-x



**Leg rest fixed with
calf support**
970650-x



Spoke protector
97092x



Mudguards
970560

For more accessories - visit our website

13

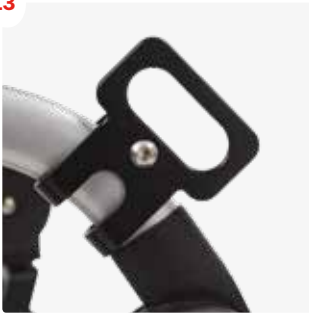

Transport fittings
970900

14

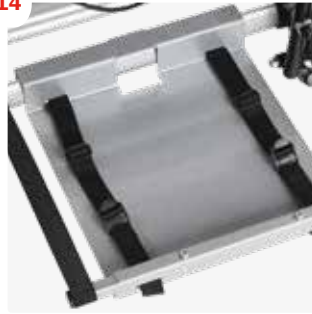

Vent tray
970815

15



Arm rest with side plates
970600-x
Without side plates
970601-x

16



Leg rest with gas strut
970500-x

17

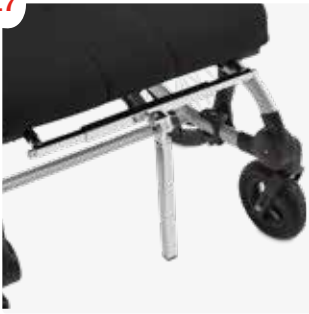

Bar for foot support
897526x
Bar for parted foot support
897528x (not shown)

18



Recline add-on
97094x

19



Foot plate model Wombat
95145-2, 95145-3, 95145-4

20

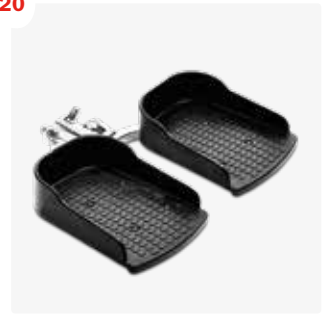

Parted foot supports
89146-x



Freedom of configuration

The Cougar comes with different types of leg rests and foot plates, to suit any user's needs.

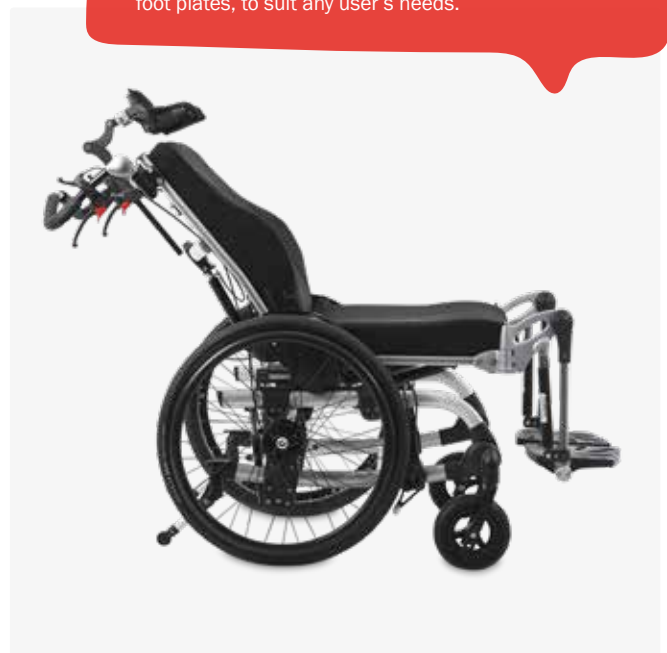



User height
650-1800 mm



Max. load
80 kg



Environment
Indoor & outdoor

x:panda[®]

x:panda is a multi-adjustable seating system that can be configured to meet a range of postural requirements and to accommodate growth. Its dynamic back allows a child to extend and push back against relatively light resistance. It is available in 4 sizes.

Highlights about x:panda



The x:panda has a unique dynamic back that absorbs the energy of extension



Multi-adjustable

Overlap in sizing means that the starting option always offers the maximum growth potential coupled with individual leg positioning to offer an improved base of support and additional support for maintaining the correct degree of abduction/adduction if required.



Growth

Individual growth in width, depth and back height extends the life of the seat and accommodates the greatest range of sizes for any chair on the market.



Back recline

The patented articulation of the back rest has been designed to eliminate shear and sliding during extension. This means that support remains uniquely in position during movement improving functionality and comfort for the user.



Standard

Hip supports - front and back with cover, ad-/abduction support with cover, spacers for seat extension, dynamic backrest, lumbar support (x:panda size 4 only), fix lock fittings for mounting of various belts and vests, lockable dynamic gas spring.

Options

| | | | | | |
|---|---|---|---|---|---|
| <p>Four sizes</p> <ul style="list-style-type: none"> - Size 1 - Size 2 - Size 3 - Size 4 | <p>Seat width</p> <ul style="list-style-type: none"> - Small - Medium - Large | <p>Back cushion</p> <ul style="list-style-type: none"> - Small - Medium - Large | <p>Seat cushion</p> <ul style="list-style-type: none"> - Small - Medium - Large | <p>Seat cushion without abduction</p> <ul style="list-style-type: none"> - Small - Medium - Large | <p>Gas spring</p> <ul style="list-style-type: none"> - Non-dynamic gas spring - Lockable dynamic gas spring (standard) |
|---|---|---|---|---|---|

It is possible to combine the different seat and back sizes: Size 1 seat with size 2 back, Size 2 seat with size 3 back, Size 3 seat with size 4 back, Size 2 seat with size 1 back, Size 3 seat with size 2 back, Size 4 seat with size 3 back.

Cushion colour back and seat



Black Pink* Red Blue Lime green

*Not available for size 4

Cushion colour seat without abduction



Black



x:panda with abduction support



x:panda with abduction support and red cushions

Measurements

| | | 1 | 2 | 3 | 4 |
|--|-----------------------------|------------------|------------------|------------------|------------------|
| | Effective seat width | 160, 200, 240 mm | 200, 240, 280 mm | 260, 310, 360 mm | 340, 400, 460 mm |
| | Effective seat depth | 160-260 mm | 220-330 mm | 260-390 mm | 380-530 mm |
| | Backrest height | 270-370 mm | 320-420 mm | 350-470 mm | 500-710 mm |
| | Max. load | 30 kg | 30 kg | 60 kg | 80 kg |
| | Max. load at transportation | 30 kg | 30 kg | 60 kg | 75 kg |
| | Backrest angle | -5° - 30° | -5° - 30° | -5° - 30° | -5° - 30° |
| | Overall width | 310, 350, 390 mm | 380, 420, 460 mm | 470, 520, 570 mm | 590, 650, 710 mm |
| | Total mass | 6,5 kg | 8,5 kg | 11 kg | 13 kg |

Further measurements at our website

Nice to know

The back height, seat width and depth adjustments, different accessories, the 16 pre-mounted fix locks and our range of frames allows you to configure complex and individualized seating solutions for a wide range of children.

The dynamic back has been documented to be associated with a better postural control and less involuntary arm movements during the extensor thrusts compared to a rigid seating system (Cimolin 2009).



Accessories

1



Back rest extension
8910655-x60

2

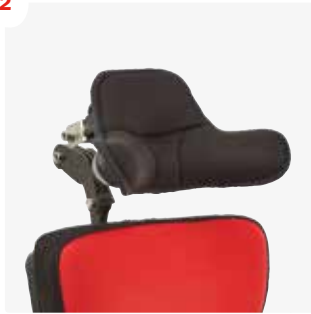

Head supports
99xxxx-xx

3

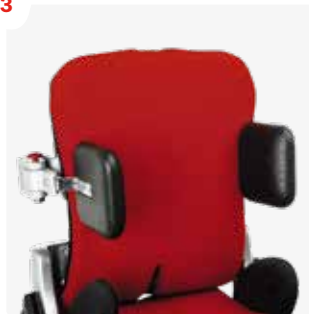

Swing-away side supports
839xx-xx

4



Fixed side supports
8910401-x, 8910401-xP

5



Upper arm supports
8910407-x0

6



Overarm supports
8910407-x

7

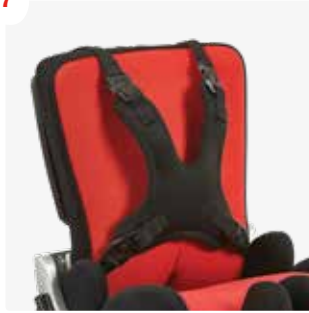

Vest and belts
89113-x

8



Non-dynamic gas spring
891100x

9



Fixed rod
891150x

10



Quick locks
8910702-x0

11



Back width extensions
8910409-45
For x:panda size 4

12



Cover plate
8910406-4
For x:panda size 4

For more accessories - visit our website

13



Foam back plate
8910406-x

14



Lumbar support
8910407

15



Hip supports
8910404-4x

16



Armrest/Daily adjustment kit
891061x-x/8910615-11

17



Extra padding
8910404-PADx

18



Armrest for tray
8910730

19



Grip handle for tray
8910750

20

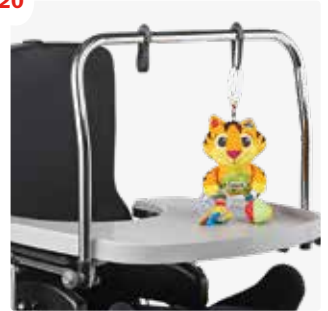

Tray/Toy bar
891072x-x/8910740

21



Pommel
8910408-x

22



Seat wedges
8910400-x
8910400-xx

23



Girth for seat cushion without abduction
891925x

24



Canopy
87401x0
Requires 9589100

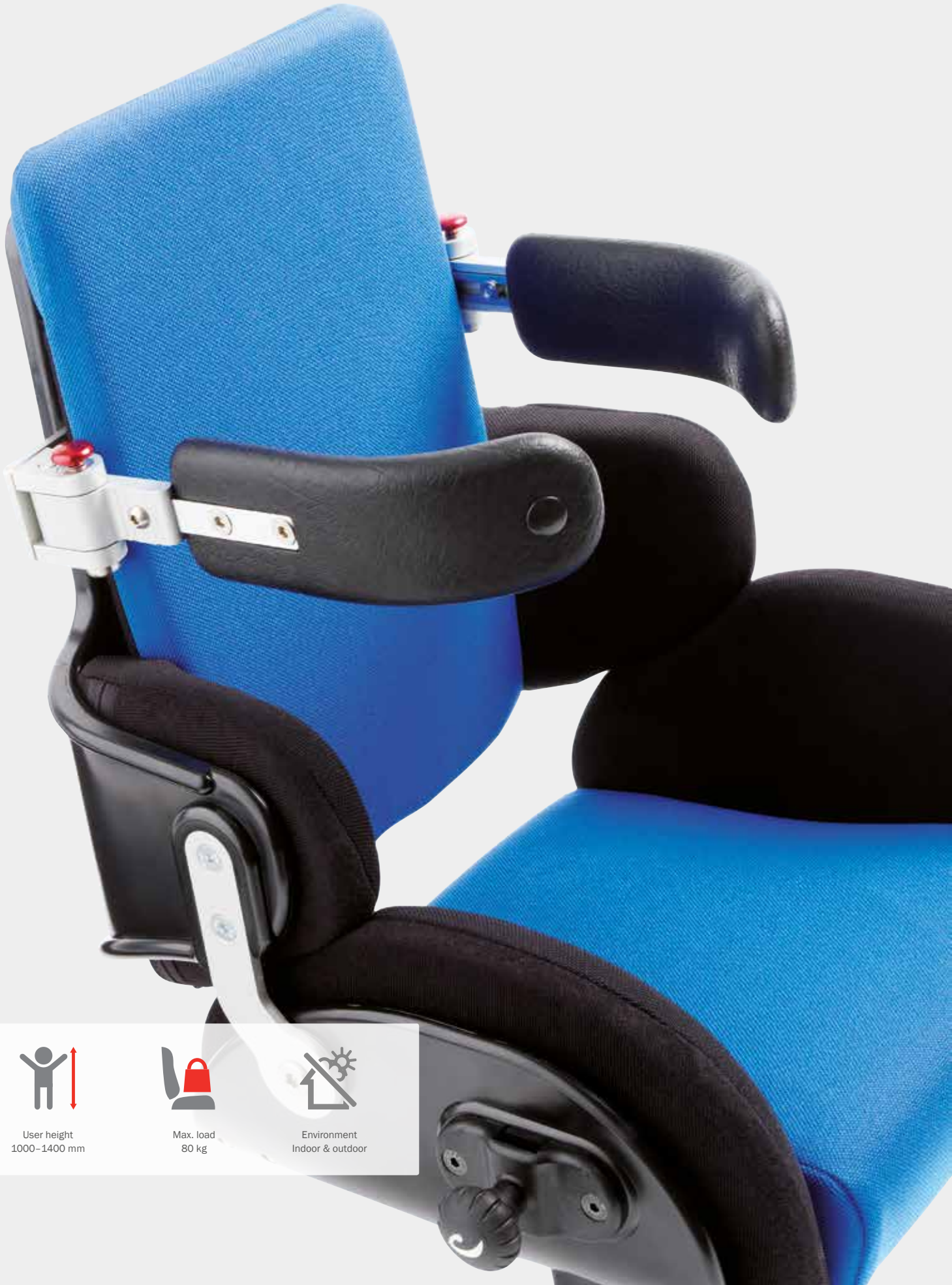

User height
1000–1400 mm



Max. load
80 kg



Environment
Indoor & outdoor

Panda Futura[®]

The Panda Futura Standard seat is primarily for children who need support around the arms and shoulders. This active seat is for active children who need more freedom of movement. Panda Futura is available in 5 sizes.

Highlights about Panda Futura



A modular seating system with comfortable, six part cushion set



Fits on a variety of frames

The Panda Futura seat can be mounted on many different frames. Also, the seat on a indoor frame is easy to dismount and place onto an outdoor frame.



Back recline

The back can be adjusted independently of the seat. The pivotal point of recline is anatomically correct, i.e. in line with the hip joint.



Accessories are easily interchangeable for user comfort



Standard

Back angling (recline), tilt in space, back and seat cushions.

Options, Panda Futura Active

Four sizes

- Size 2
- Size 2 ½
- Size 3
- Size 4

Cushions

- Narrow
- Wide

Options, Panda Futura Standard

Five sizes

- Size 1
- Size 2
- Size 2 ½
- Size 3
- Size 4

Cushions

- Narrow
- Wide

Cushion colour



Blue



Red

Shell colour









Black









Panda Futura standard



Measurements

| Panda Active | | 2 | 2½ | 3 | 4 |
|---|----------------------|-----------|------------|-----------|-----------|
|  | Effective seat width | 220 mm | 250 mm | 290 mm | 320 mm |
|  | Effective seat depth | 240 mm | 280 mm | 310 mm | 360 mm |
|  | Backrest height | 350 mm | 380 mm | 400 mm | 450 mm |
|  | Max. load | 30 kg | 50 kg | 50 kg | 60 kg |
|  | Backrest angle | -4° - 27° | -10° - 20° | -9° - 27° | -6° - 17° |
|  | Total mass | 5,2 kg | 5,6 kg | 6,2 kg | 7,5 kg |

Further measurements at our website

| Panda Standard | | 1 | 2 | 2½ | 3 | 4 |
|---|-----------------------------|-----------|------------|------------|-----------|-----------|
|  | Effective seat width | 220 mm | 220 mm | 250 mm | 290 mm | 320 mm |
|  | Effective seat depth | 220 mm | 240 mm | 280 mm | 310 mm | 360 mm |
|  | Backrest height | 290 mm | 390 mm | 410 mm | 440 mm | 535 mm |
|  | Max. load | 30 kg | 30 kg | 50 kg | 50 kg | 60 kg |
|  | Max. load at transportation | | 30 kg | 50 kg | 50 kg | 57 kg |
|  | Backrest angle | -3° - 28° | -15° - 32° | -10° - 35° | -5° - 36° | -5° - 30° |
|  | Total mass | 5,7 kg | 5,7 kg | 6,2 kg | 7,3 kg | 8,7 kg |

Further measurements at our website

Nice to know

The design of the seat and accessories ensure that the seat is easy to use and clean. The two versions; the standard and active ensure the possibility to customize the product to the activity level of the individual user.

The Panda Futura seat is popular in settings, where reuse, financially viable and less complex seating systems are warranted.



Accessories



Head supports
99xxxx-xx

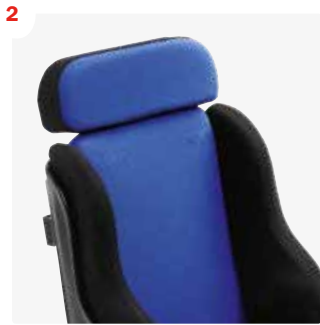

Back extension
89655-xxx



Back extension, curved
89658-xxx



Wedge cushions
89760-x



Swing-away side supports
83xxx-xxx



Fixed side supports
94110-x

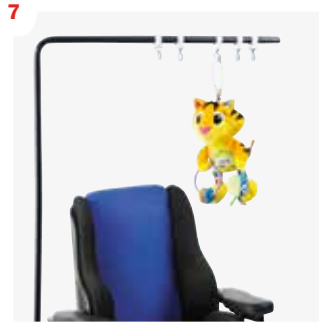

Toy bar
89200



Pommel
89130-xxx



Seat extension, curved
89742-xxx



Activity centre
89250



Push brace
8997x



Push handles
89545 Panda Futura Standard
89548 Panda Futura Active

For more accessories - visit our website

13



Tray, transparent
89230-x

14

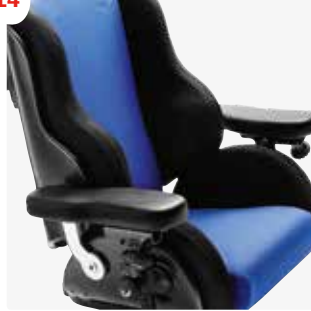

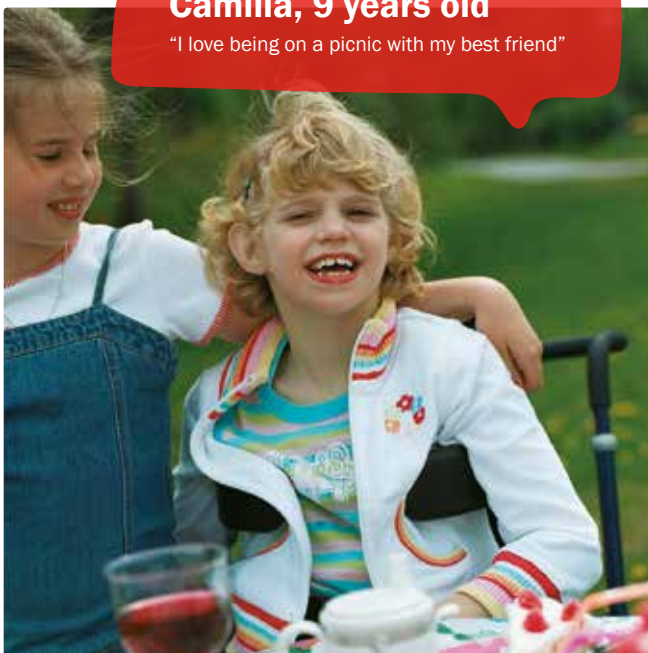

Arm rest
8961x



Camilla, 9 years old
"I love being on a picnic with my best friend"





| | | |
|--|--|---|
|  <p>User height 1600 mm</p> |  <p>Max. load 85 kg</p> |  <p>Environment Indoor & outdoor</p> |
|--|--|---|

Panda Futura 5[®]

The Panda Futura size 5 is a comfortable supportive seat for larger children and teenagers. The seat is available in two versions; Standard and Active which provides the required comfort, support and freedom of movement.

Highlights about Panda Futura 5



A range of accessories can be added



Easy change - active to standard

Mount separate sideplates and cushions and the seat is easily transformed into the standard model. Sideplates and side cushions are accessories.



Comfortable cushions



Angle adjustable back

Activate the handle on the back to carry out a smooth and stepless angle adjustment of the back.



Standard

Available as Standard for more comfort and Active for more freedom of movement in the trunk. Angle adjustable back from -5° to 30°.

Options

Size

- One size (Size 5)

Cover



Gemma



Mesh



Panda Futura 5, Standard



Panda Futura 5, Active

Measurements

| | | Active | Standard |
|--|-----------------------------|-----------|-----------|
| | Effective seat width | 350 mm | 350 mm |
| | Effective seat depth | 430 mm | 430 mm |
| | Backrest height | 590 mm | 590 mm |
| | Max. load | 85 kg | 85 kg |
| | Max. load at transportation | 85 kg | 85 kg |
| | Backrest angle | -5° - 30° | -5° - 30° |
| | Length | 560 mm | 560 mm |
| | Overall width | 560 mm | 560 mm |
| | Total mass | 15 kg | 15 kg |

Further measurements at our website

Nice to know

Panda Futura 5 is our seat for the largest users. It comes in two versions (standard and active) with a max. load of 85 kg and a user height of 1700 mm, which makes the Panda Futura 5 suitable for most youngsters with cerebral palsy who need adaptive seating. According to the clinical growth charts for children with cerebral palsy less than 10% of the children and youngsters weigh more than 85 kg (Brooks 2011).



Accessories



Head support
99xxxx-xx

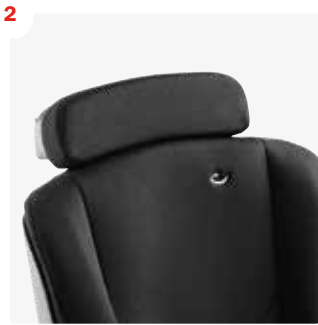

Back extension
89658-xxxx



Tray
8910725-5



Back sides
89811-5xx



Vest
85430-x



Seat extension
89642-xxx

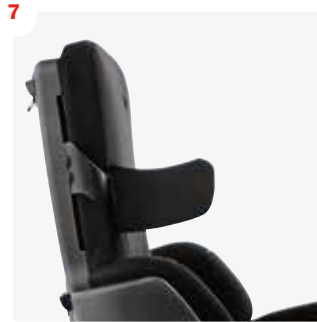

Fixed side support
8910401-4

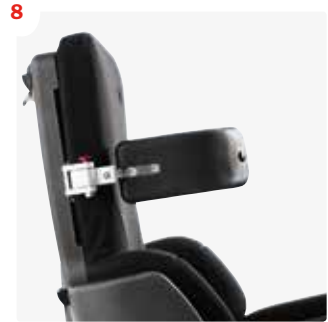

Swing-away side support
83xxx-xxx

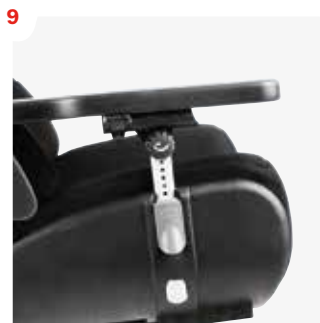

Arm rest
89619-x



Pommel
89930-5



For more accessories - visit our website

The pivotal point of recline is anatomically correct, being in line with the hip joint. The back angles from -5° to 30°

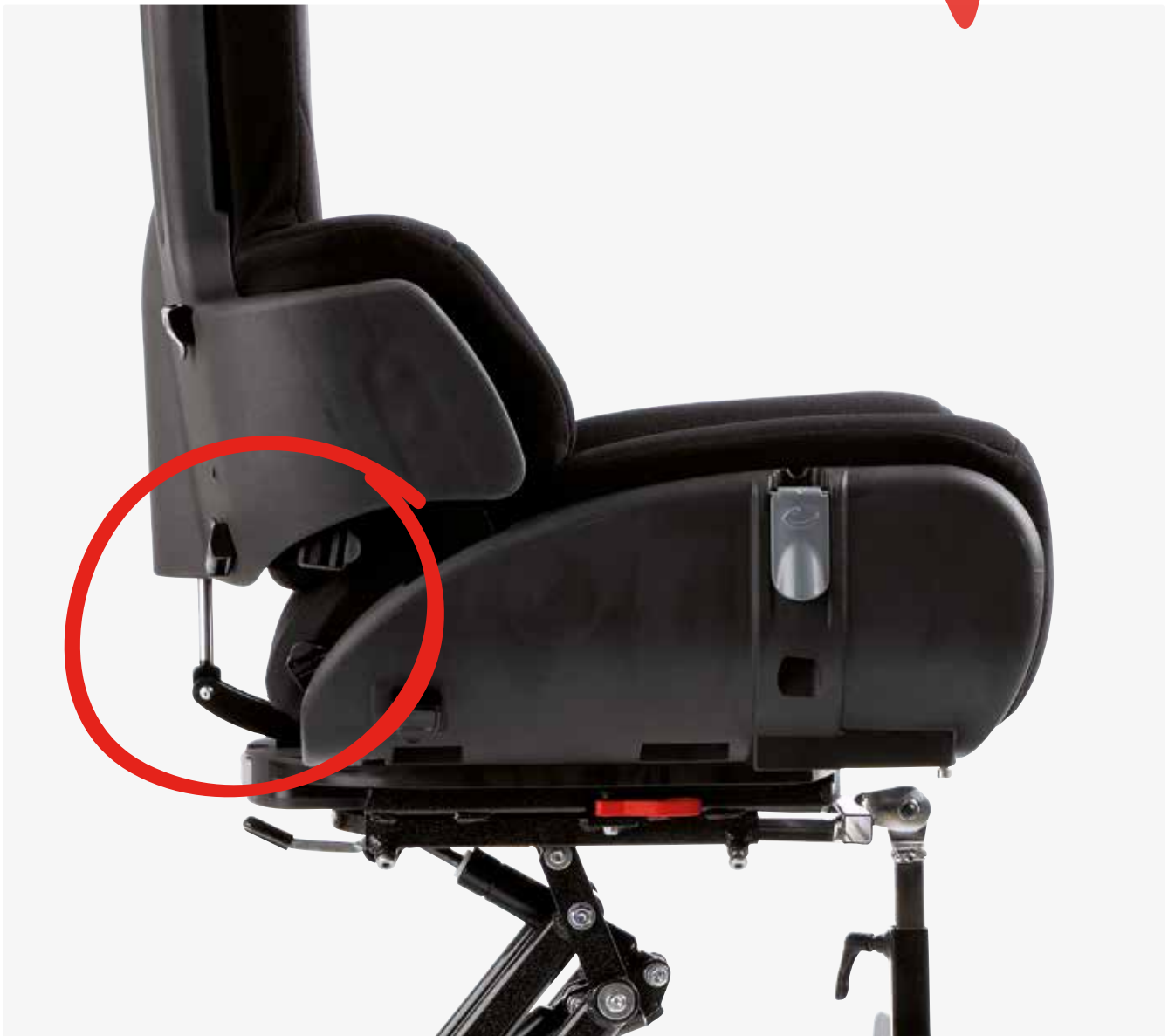

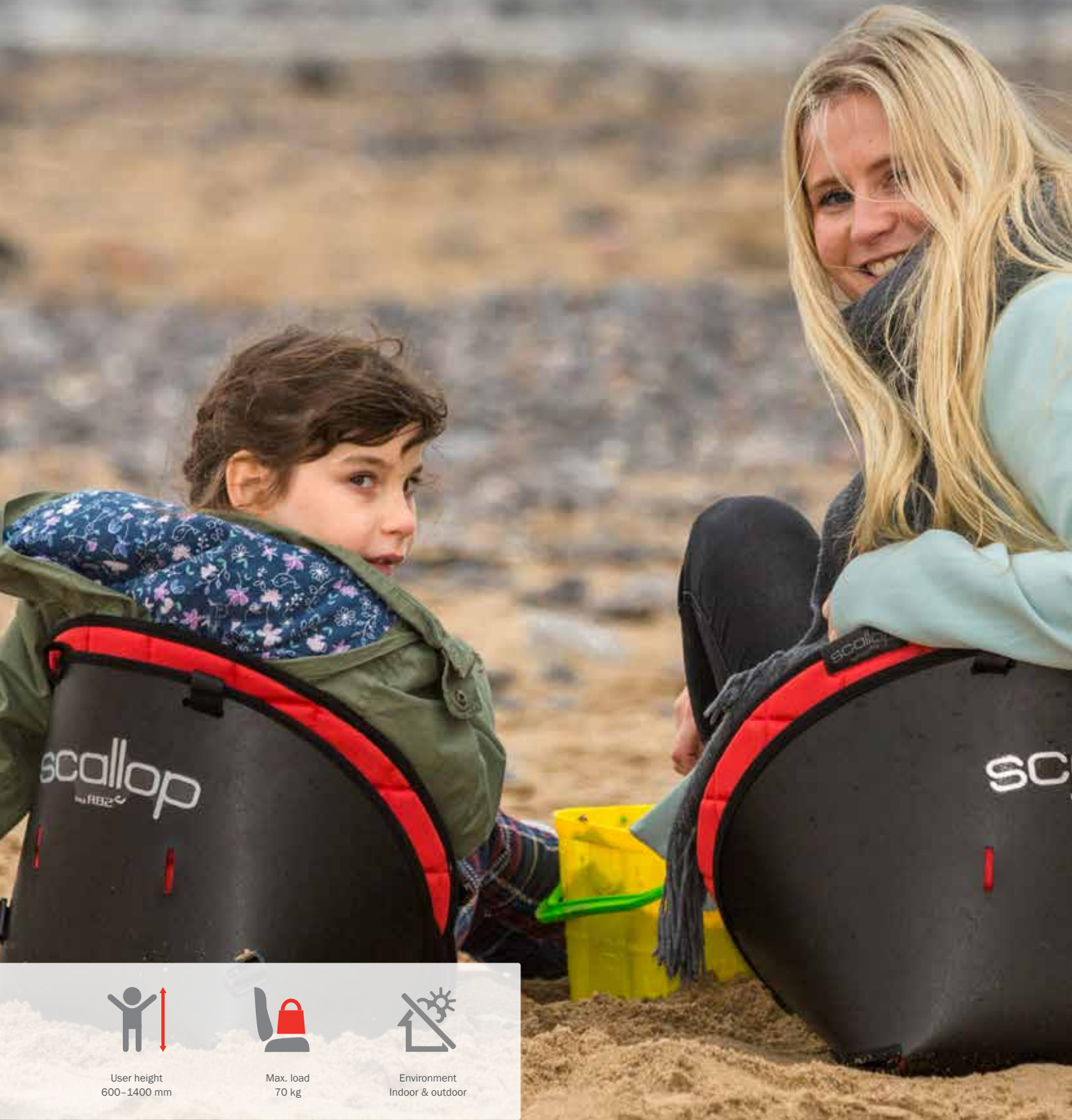

User height
600-1400 mm



Max. load
70 kg



Environment
Indoor & outdoor

Scallop[®]

The Scallop is designed to aid floor sitting and to add extra support whilst sitting on a chair. Used by infants, children, teenagers and adults with mild to moderate disabilities as well as those without disabilities. It comes in four sizes.

Highlights about Scallop

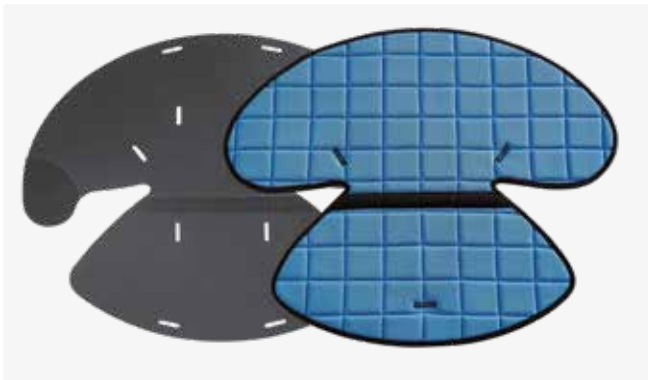

Removable cushion

The Scallop cushions come in two reversible colours and can be easily removed from the shells and machine-washed at 60°.



Simple and flexible



Portable and lightweight

Weighing less than 2kg, the Scallop is easy to travel with. You can carry the product using the two handles provided.



Versatile

The Scallop is not only used for long sitting. It can also be attached to a wide variety of chairs to add extra support while sitting around a table to enable participation in everyday activities.



Standard

Carry straps, seat pit, 3-point belt for size 1 and 2, 2-point belt for size 3 or 4.

Options

Four sizes

- Size 1
- Size 2
- Size 3
- Size 4

Cushion colours

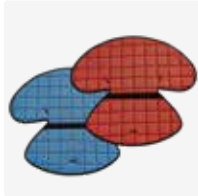

Red/Blue reversible cushion

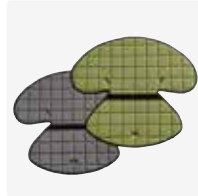

Grey/Green reversible cushion

Nice to know

Scallop provides the child with a sense of safety and security through tactile input of the seat on the body. It can be used on the floor or strapped to a chair to enhance social interaction and communication with peers.



Standard Scallop Size 1 or 2. Available in red/blue or grey/green reversible cushion



Standard Scallop Size 3 or 4. Available in red/blue or grey/green reversible cushion

Measurements

| | | 1 | 2 | 3 | 4 |
|--|-------------|------------|------------|------------|------------|
| | Hip width | 150-210 mm | 210-240 mm | 240-270 mm | 270-380 mm |
| | Back height | 330-380 mm | 380-420 mm | 420-470 mm | 470 + mm |
| | Max. load | 15 kg | 22 kg | 29 kg | 70 kg |
| | Total mass | 0,60 kg | 0,78 kg | 1kg | 1,44 kg |

Further measurements at our website





User height
750-1900 mm



Max. load
70 kg



Environment
Indoor only

Wombat Living[®]

The Wombat Living is a cool activity chair for both toddler, pre-school, school children, teens and youngsters. The fresh look with modern colours makes it suitable for use in any indoor environment.

Available in 3 sizes.

Highlights about Wombat Living



Tilt in space

The seat unit tilts from -20° to 15° to accommodate both relaxed and active sitting postures.



Angle adjustable push brace



Small details - big difference

The cushions are made from thick comfortable foam with breathable covers. Small details like shaped cushion that protect the user's knees and extra durable edges, make a big difference in everyday use.



Built-in growth

Wombat Living offers stepless adjustment for growth. Move the backrest forward or backward and adjust the hip supports to fit any user size. The hip supports can also be angled to support the user's hips and thighs.



Standard

Tilt in space, back recline and prone angle, adjustable seat depth, adjustable back height, height and angle adjustable foot support.

Options

| | | | | |
|--|---|---|--|---|
| <p>Sizes</p> <ul style="list-style-type: none"> - Size 1 - Size 2 - Size 3 | <p>Backs</p> <ul style="list-style-type: none"> - Long back - Short back | <p>Castors</p> <ul style="list-style-type: none"> - 75 mm with brake - 100 mm with brake - Central brake for 100 mm castors | <p>Height adjustment</p> <ul style="list-style-type: none"> - Pedal on the frame - Release handle on the push brace - Power actuator | <p>Seat angle adjustment</p> <ul style="list-style-type: none"> - Release handle beneath the seat - Release handle on the push brace |
|--|---|---|--|---|

Frame colour



Anthracite grey



White

Cushion colour



Red



Petroleum



Grey



Grey contoured













Wombat Living with power actuator



Wombat Living with release handle on push brace

Measurements

| | | 1 | 2 | 3 |
|---|------------------------------------|------------|------------|------------|
|  | Effective seat width | 300 mm | 370 mm | 420 mm |
|  | Effective seat depth | 180–310 mm | 250–380 mm | 320–500 mm |
|  | Backrest height | 280–340 mm | 310–380 mm | 390–475 mm |
|  | Backrest height (High Back) | 360–430 mm | 395–460 mm | 460–550 mm |
|  | Seat surface height at front edge* | 360–650 mm | 360–650 mm | 390–670 mm |
|  | Max. load | 45 kg | 45 kg | 70 kg |
|  | Backrest angle | 0°–28° | 0°–28° | 0°–33° |
|  | Seat plane angle | –15°–20° | –15°–20° | –10°–22° |
|  | Length | 600 mm | 600 mm | 720 mm |
|  | Overall width | 550 mm | 550 mm | 610 mm |
|  | Total mass** | 15,5 kg | 15,5 kg | 22 kg |

*Measured with 75 mm castors ** Measured with gas spring Further measurements at our website

Nice to know

Use the Wombat Living for daily activities such as reading and learning at school, having fun with friends and when helping with daily chores at home.

The height adjustable frame and the anterior tilt function ease standing transfer into the chair and ensures that unnecessary and repetitive lifting is avoided.

Although the Wombat Living at first glance looks simple and for children with mild to moderate impairments, it is possible to use the large range of accessories to adapt the chair to users with more comprehensive needs for support for the feet, knees, thighs, pelvis, trunk and head.



Accessories

1



Head supports
9913092-83

2



Lumbar wedge
955030-x

3



Side supports, fixed
95121

4



Hip supports
95110-1, 95111-1
Covers for hip supports
95110-60, 95111-60

5



Arm rests
95112-1, 95113-1, 95114, 95115

6



Tray, smoke- coloured
95125, 95126

7



Hip-belt
89661-4P

8



Pommel
95130-x

9



Knee abduction pommel
95230-10

10



Power kit
95550, 95550-3

11



Anti-tip device
95953

12



Incontinence seat cover
95562x-282

For more accessories - visit our website

13



Lower back extension
95140-60

14



Pelvis support without sides
95140-xx

15



Pelvis support with sides
95140-xx

16



Back rest and seat cushion contoured
Back rest cushion: 95503x-238
Seat cushion: 95502x-238

17



Adjustable push brace
95147

18



Helper's handles
95145

19

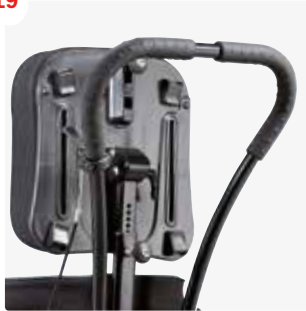

Adjustable push brace, seat mounted
95148-1, 95148-3

20



Back rest and seat cushion
Back rest cushion: 95503x-2xx
Seat cushion: 95502x-2xx

Silas & Benjamin

"Do our homework or go to the canteen..."





User height
850-1400 mm



Max. load
50 kg



Environment
Indoor & outdoor

Cricket[®]

The Cricket is a lightweight foldable buggy designed to suit you and your child's needs and lifestyle. This user-friendly buggy comes in two sizes and it adapts to the child's growth in several areas maximizing the number of years it can be used.

Highlights about Cricket



Back recline

For extra comfort, Cricket has a two-position back recline option for the user to change from a sitting position to a relaxed position. The backrest angle can be adjusted from 110° to 125°.



Growth adaptable



Easy Fold - Light weight

This lightweight buggy is extremely compact when folded and requires minimum storage space.



Height & angle adjustable foot support

The Cricket comes with a unique foot support that can be height and angle adjusted to support the individual needs.



Standard

Back recline, adjustable seat depth, height and angle adjustable foot support, angle adjustable push brace, front wheel with swivel, rear wheel with parking brake, compact and foldable.

Options

- Seat**
- Size 1
 - Size 2

Cushion colour



Blue



Red



Green



Pink



Grey



Yellow

















Orange



Cricket standard

Measurements

| | | 1 | 2 |
|---|-----------------------------------|------------|------------|
|  | Effective seat width | 340 mm | 395 mm |
|  | Effective seat depth | 210–310 mm | 310–430 mm |
|  | Backrest height | 500 mm | 570 mm |
|  | Seat surface height at front edge | 500–530 mm | 540–580 mm |
|  | Max. load | 35 kg | 50 kg |
|  | Max. load at transportation | 27 kg | 43 kg |
|  | Backrest angle | 110–125° | 110–125° |
|  | Seat plane angle | 20° | 20° |
|  | Length | 750 mm | 750 mm |
|  | Overall width | 525 mm | 575 mm |
|  | Folded length | 760, mm | 760 mm |
|  | Folded width | 355 mm | 355 mm |
|  | Folded height | 485 mm | 485 mm |
|  | Total mass | 12,4 kg | 13,4 kg |

Further measurements at our website

Nice to know

Cricket's lightweight frame is one of the most compact on the market. The frame is designed to support and ensure stability for the buggy.

The height of the push brace on the Cricket can easily be changed using the angle adjustment and the 360° turnable front wheels ensure a smooth ride and makes it easy to steer. The puncture-proof wheels provide exceptional performance. Explore the experience of the smoothest ride - from city to tougher trails, from sun to rain.

Furthermore, the Cricket is approved for transportation and complies with ISO 7176-19, for safe transportation in vehicles.



Accessories



1
Back rest height extension
87043160-1, 87043160-2



2
Head rest cushion
87043150



3
Sculpted head rest cushion
87043151



4
Folding top
8704317-x, 8704327-x



5
Arm rests
87043120-1, 87043120-2



6
Tray
87043180-1, 87043180-2



7
Grip bar in arm rests
87043181-1, 87043181-2



8
Grip bar in frame
87043182-1, 87043182-2



9
Heel straps
87043185



10
Rucksack
87043183-1



11
Shopping net
87043184-1, 87043184-2



12
Calf support strap
87043190-1, 87043190-2

For more accessories - visit our website



13
Wedges for shaping and width reduction
87043130-x, 87043140-x



14
Wedges for shaping seat and back
87043140-x



15
Transport fittings
87043188



16
Directional locking mechanism, front wheels
87043187

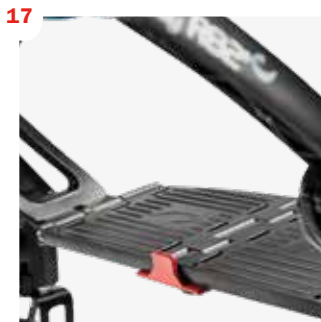

17
Additional locking mechanism for foot plate
87043186



18
Rain cover
87467-210, 87467-310

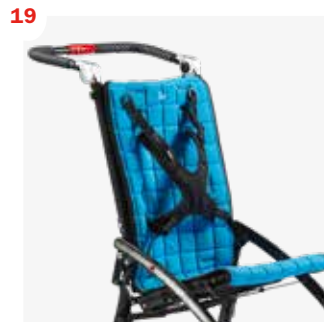

19
Neoprene vest
89113-x



20
Y-hip strap upholstered
85427-x

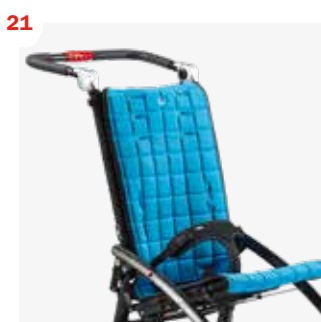

21
Belt harness neoprene
89114-x

Isabella, 4 years old
"I am ready for summer"





User height
750-1500 mm



Max. load
40 kg



Environment
Indoor & outdoor

Stingray[®]

Stingray is a superbly stylish buggy with tool free adjustment of postural support and unique swivel action for forward/rearward facing options.

The Stingray is available in 2 sizes.

Highlights about Stingray



Foldable

The Stingray is folded quickly and fits into almost any car. Fold the seat and frame units separately or altogether and pack it into your car - soon you will be on your way.



180° turnable seat unit



Tilt in space and back recline

Perfect seating position due to adjustable seat tilt and back angle adjustment. The seat unit tilts 45° and the back reclines down, allowing your child to rest while out and about.



Safe transportation in vehicles

The Stingray complies with ISO 7176-19, for safe transportation in motor vehicles. The Stingray is approved for transport in vehicles of a user weight of up to 40 kgs.



Standard

Tilt in space, back recline, adjustable seat depth, adjustable back height, height and angle adjustable foot support, turnable seat, frame one size.

Options

| | | | | |
|---|---|--|--|---|
| Seat <ul style="list-style-type: none">- Size 1- Size 2 | Front wheels <ul style="list-style-type: none">- 12" solid or air, no swivel- 7" solid or air, turnable front wheels, with directional stabilizer | Foot brake <ul style="list-style-type: none">- Individual- Central | Hand brake <ul style="list-style-type: none">- Hand brakes- No hand brakes | Foot rest <ul style="list-style-type: none">- Long bar- Short bar |
|---|---|--|--|---|

Cushion colours

















Standard Stingray with 12" no swivel front wheels



Standard Stingray with 7" turnable front wheels, with directional stabilizer

Measurements

| | | 1 | 2 |
|---|-------------------------------------|------------|------------|
|  | Effective seat width | 300 mm | 350 mm |
|  | Effective seat depth | 180-300 mm | 250-400 mm |
|  | Backrest height | 410-550 mm | 500-650 mm |
|  | Seat surface height at front edge** | 520 mm | 520 mm |
|  | Max. load | 40 kg | 40 kg |
|  | Max. load at transportation | 40 kg | 40 kg |
|  | Backrest angle | 170° | 170° |
|  | Seat plane angle | 45° | 45° |
|  | Length* | 740 mm | 740 mm |
|  | Overall width | 590 mm | 590 mm |
|  | Folded length | 900 mm | 900 mm |
|  | Folded width | 590 mm | 590 mm |
|  | Folded height | 490 mm | 490 mm |
|  | Total mass | 19 kg | 20 kg |

* Note: The configuration of the product ** Measured to adaptorplate Further measurements at our website

Nice to know

The big range of accessories, flexible adjustment of the foot support and hip and side supports on the Stingray allows to make a comfortable and supportive seating solution for the individual user.

The Stingray has supreme driving properties, fantastic suspension and with the safe and stable brakes, security always has pride of place.



Accessories



Folding top
8740110, 8740120



Head rest cushion
8740810, 8740820



Sculpted head support
872083x



Anatomic head rest
8720862, 8720863



Two-part head support
8720870

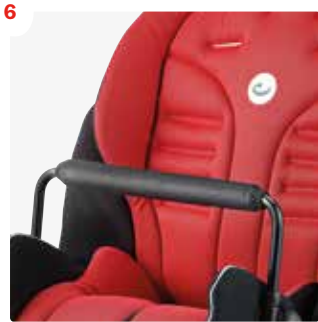

Grip handle
872040x

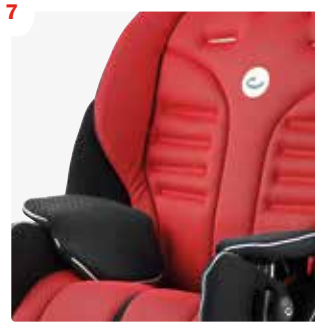

Hip supports
87402x0

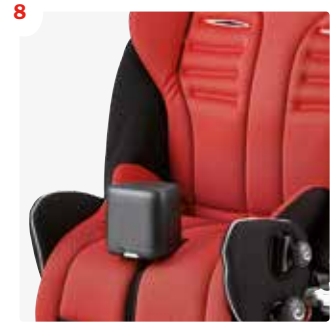

Pommel
872050x

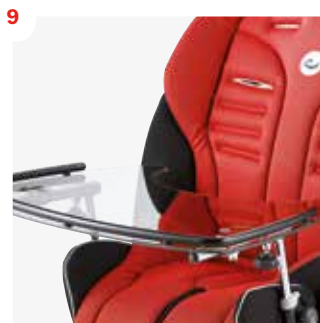

Tray
87200x0
8776350

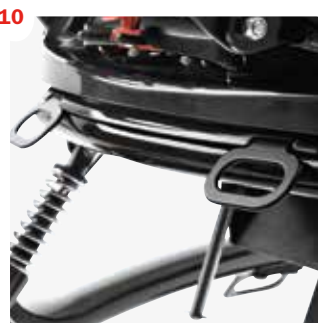

Transport fittings
8720902

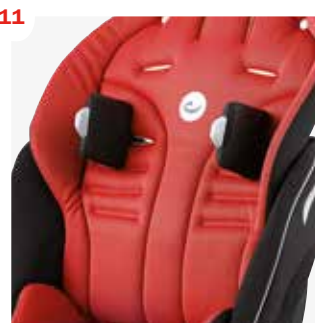

Side supports
872030x
Covers for knobs on side supports
8720360



Foam back plate
877632x

For more accessories - visit our website

13



Hip belt
85427-x

14



Oxygen bottle holder
8776295

15



Bunting bag
874013x

16



Vent tray
8776290

17



Shopping basket
8720600

18



Head rest fitting
8720850

19



Rain cover
872014x

20



Backpack
87207x1



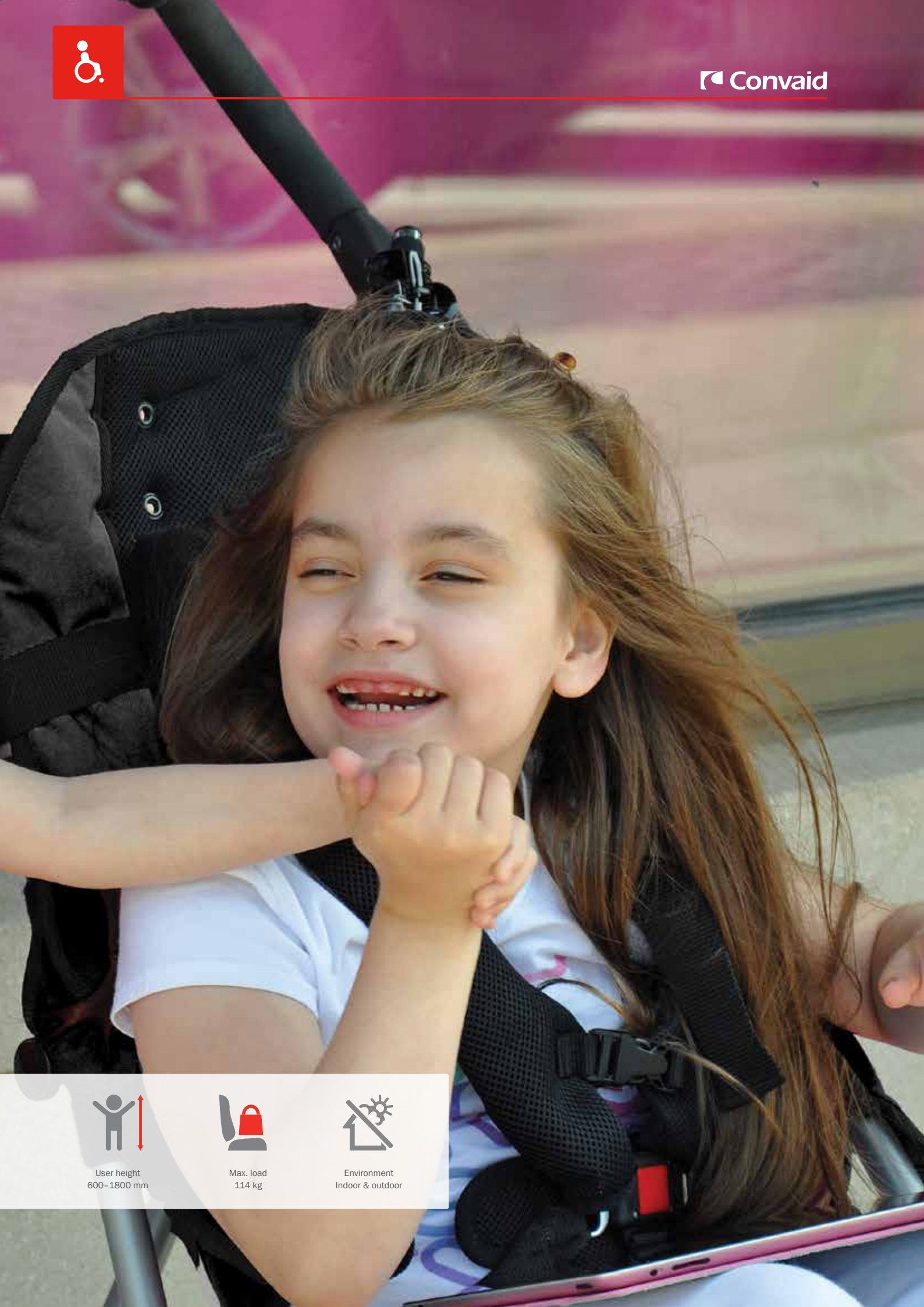

User height
600-1800 mm



Max. load
114 kg



Environment
Indoor & outdoor

Cruiser

The Convaid Cruiser is a 30° fixed-tilt pediatric wheelchair that is convenient, lightweight and compact folding. The Cruiser is custom-built to meet each individual requirements. It comes equipped with Convaid's proprietary self-tensioning seating system, Self-Tensio™, which provides increased seating tolerance and can help promote neutral pelvic positioning.

Highlights about Cruiser



Customisable growth capabilities

Adjustable seat depth extends chair life for a growing child.



30° fixed tilt

Increased tilt angle improves postural control through upper body positioning.



Foldable

The Cruiser is folded quickly and fits into almost any car.



Self-Tensio™

Built in self-tensioning seating system increases sitting tolerance.



Standard, Cruiser Standard

Solid and foldable frame, fixed tilt, anatomic back, flip-up armrest, 2-point positioning belt, off road tires, castor lock, toggle wheel locks, attendant brake and swing-away foot plates.

Standard, Cruiser Scout

Solid and foldable frame, 30° fixed tilt, seat depth growth, one-piece angle adjustable push brace (CX12-CX16) or two-piece push handle (CX18) 2-point positioning belt, quick release rear wheels, castor lock, toggle wheel locks and removable adjustable swing-away foot plates.

Options

| Size: | Model | Tyres |
|--------|--------------------------------------|---------------------------|
| - CX10 | - Standard with foot brake | - Solid |
| - CX12 | - Scout | - Air |
| - CX14 | - Standard with attendant hand brake | - Solid w/transp. fitting |
| - CX16 | | - Air w/transp. fitting |
| - CX18 | | |

Cushion colours



Royal blue Cherry red Panther black Pink Purple Green

Frame colour



Silver













Cruiser Scout 16"



Cruiser standard 18"

Measurements

| | | CX 10 | CX 12 | CX 14 | CX 16 | CX 18 |
|---|---------------------------|--------------|--------------|--------------|--------------|--------------|
|  | Effective seat width | 255 mm | 305 mm | 355 mm | 405 mm | 455 mm |
|  | Effective seat depth | 152-299 mm | 200-330 mm | 254-380 mm | 279-406 mm | 356-533 mm |
|  | Backrest height | 530 mm | 560 mm | 640 mm | 710 mm | 640 mm |
|  | Total mass | 12 kg | 12 kg | 13 kg | 14kg | 14 kg |
|  | Max. load regular/transit | 34/30 kg | 34/30 kg | 45,5/45,5 kg | 77/77 kg | 114/77 kg |
|  | Overall width | 560 mm | 600 mm | 650 mm | 700 mm | 724 mm |
|  | Length | 1220 mm | 1120 mm | 1245 mm | 1320 mm | 1400 mm |
|  | Overall height | 940 mm | 970 mm | 940 mm | 1020 mm | 970 mm |
|  | Folded length | 1190 mm | 1220 mm | 1190 mm | 1350 mm | 1270 mm |
|  | Folded width | 380 mm | 380 mm | 410 mm | 410 mm | 380 mm |
|  | Folded height | 430 mm | 430 mm | 430 mm | 430 mm | 430 mm |

Further measurements at our website

Nice to know

- The Cruiser is lightweight and has an easy three dimensional fold, which mean it requires minimal storage space and is easy to take along.
- The individual angle adjustable footplates allows for optimum leg and foot positioning.



Accessories



Extended headrest cover
 With or without windows (Canopy)
 CX10 C904736/C904720
 CX12 C904737/C904721
 CX14 C904738/C904722
 CX16 C904739/C904723
 CX18 C904740/C904724

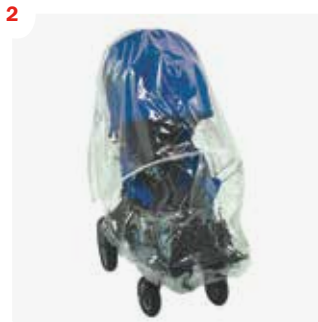

Rain cover
 CX10-14 C904939
 CX16-18 C904910



Headrest extension
 Curved cordura (black)
 CX10 C903332
 CX12 C902863
 CX14 C900484
 CX16 C900138
 CX18 C902619



Headwings
 Padded:
 CX10 C903331
 CX12 C902862
 CX14 C900681
 CX16 C900142
 CX18 C902618
 Occi: C904779



3-pt positioning belt
 C904017
 With depth adjustment croch strap



H-harness with padded covers
 C903988
 3-pt position belt required



Full support torso vest
 CX10 C903330
 CX12 C902861
 CX14 C900680
 CX16 C900339
 CX18 C902616



Soft lateral support
 Single/Double flap
 CX10 C903328/C903329
 CX12 C902859/C902860
 CX14 C900678/C900679
 CX16 C900140/C900204
 CX18 C902614/C902615

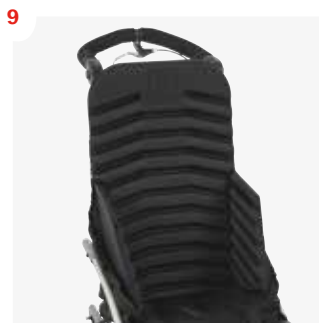

Reducer seat insert
 Seat width 5 cm smaller, seat depth 2,5 cm smaller
 CX10 C904211
 CX12 C904111
 CX14-18 C904110



Calf panel
 C904580



Medial thigh support-abductor
 with position/align cushion
 CX10 C903326
 CX12 C902857
 CX14 C900480
 CX16 C900137
 CX18 C902607



Lateral thigh support-abductor
 with position/align cushion
 CX10 C903327
 CX12 C902858
 CX14 C900482
 CX16 C900188
 CX18 C902608



Angle adjustable footplates
 CX10 C903445
 CX12-14 C903268
 CX16-18 C903269



Footplate securement strap
 C903584



Foot positioners
 Small (18-25 cm) C903415
 Medium (20-28 cm) C903416
 Large (23-30 cm) C903417



Upper extremity support surface
 Clear tray
 CX10 C903078
 CX12 C903385
 CX14 C903386
 CX16 C903387
 CX18 C903388



Anchor transit kit
 CX10-16 C997125
 CX18 C997141
 Scout model:
 CX12-16 C997219
 CX18 C997220



Anti-tip
 CX10-12 C904520
 CX14-16 C904540

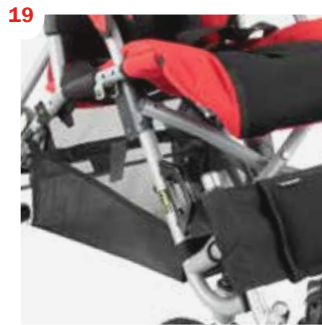

Under seat storage basket
 CX10-12 C904520
 CX14-16 C904540
 CX18 C904048



Utility bag
 C904531



Saddle bag
 C904094

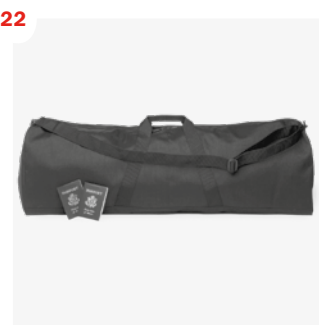

Wheelchair travel bag
 C902022

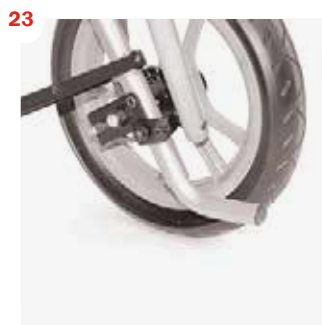

Curb tipper
 CX10-16 C904128
 CX18 C903916
 Scout: C903916



Incontinence cushion liner
 C902324

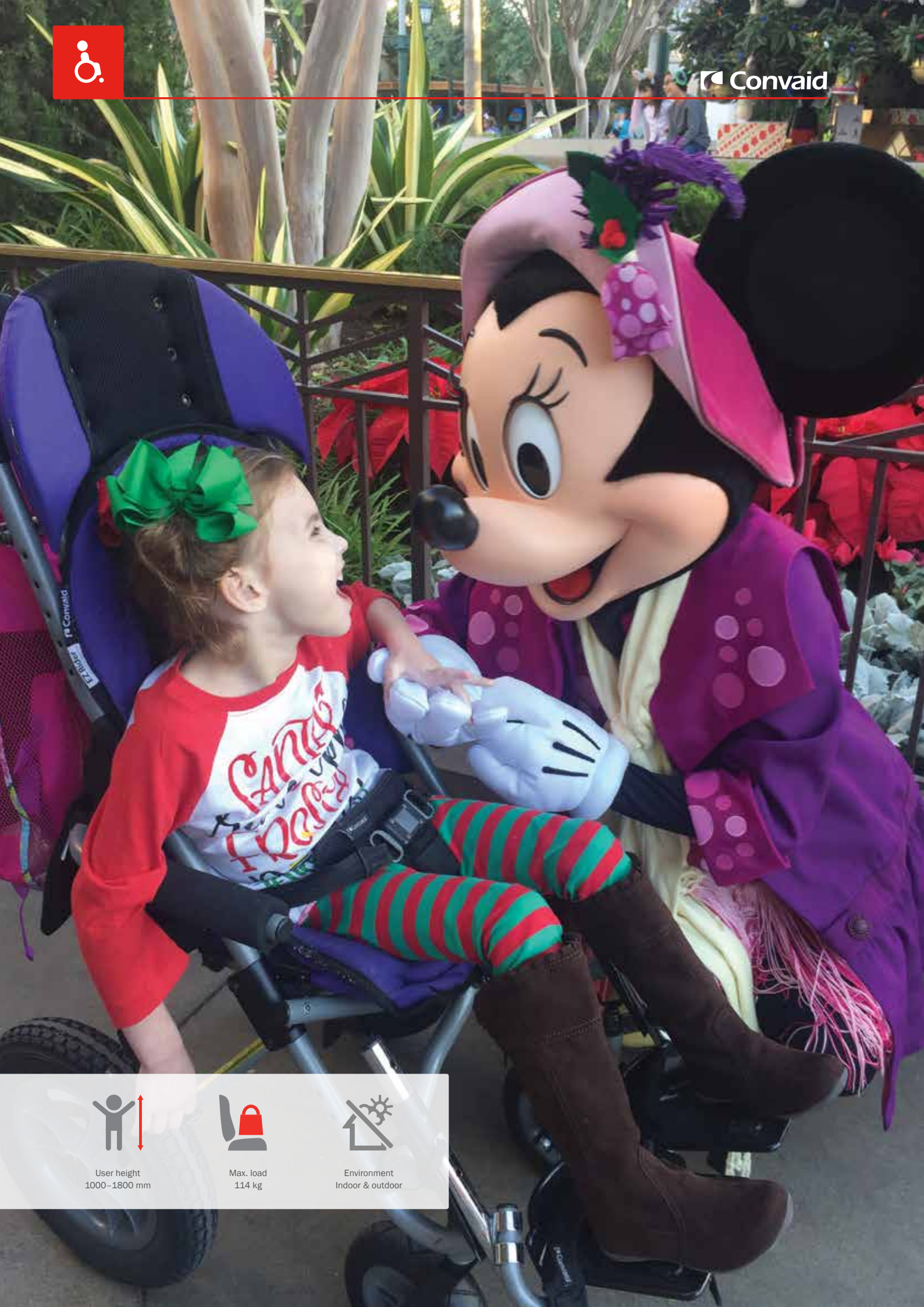

User height
1000-1800 mm



Max. load
114 kg



Environment
Indoor & outdoor

EZ Rider

The Convaid EZ Rider is an upright, 10° fixed tilt pediatric wheelchair that is best-in-class, convenient, lightweight and compact folding. The EZ Rider is custom-built to meet each individual requirements.

Highlights about EZ Rider



Customisable growth capabilities

Adjustable seat depth extends chair life for a growing child.



10° fixed tilt

Provides upright posture to enhance functional positioning.



Upholstery & colours

Removable, washable Cordura available in various colours.

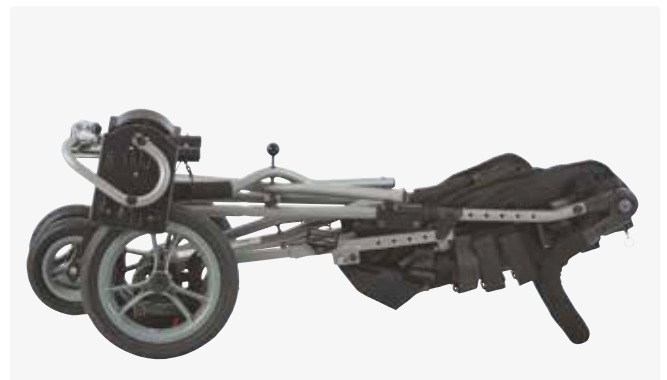

Foldable

The EZ Rider is folded quickly and fits into almost any car.



Standard

Removable adjustable swing-away footplates, one-piece, angle adj. push handle (CX12/14/16), 2-Piece Push Handles (CX18), 30-degree fixed tilt, 2-point positioning belt, seat depth growth of 13 cm, individual footbrake.

Options

| | |
|--------------|---------------------------|
| Size: | Tyres |
| - EZ12 | - Solid |
| - EZ14 | - Air |
| - EZ16 | - Solid w/transp. fitting |
| - EZ18 | - Air w/transp. fitting |

Cushion colours

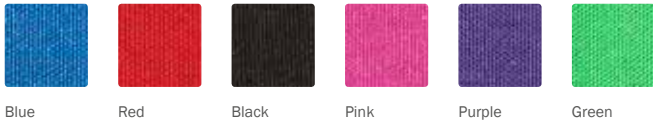

Blue Red Black Pink Purple Green

Frame colour



Silver



EZ Rider Standard, size 12" - 16"



EZ Rider Standard, size 18"

Measurements

| | | EZ 12 | EZ 14 | EZ 16 | EZ 18 |
|---|---------------------------|--------------|--------------|--------------|--------------|
|  | Effective seat width | 305 mm | 355 mm | 405 mm | 455 mm |
|  | Effective seat depth | 230-360 mm | 280-410 mm | 305-430 mm | 370-495 mm |
|  | Backrest height | 530 mm | 610 mm | 660 mm | 680 mm |
|  | Total mass | 11 kg | 14 kg | 14kg | 13 kg |
|  | Max. load regular/transit | 34/30 kg | 45,5/45,5 kg | 77/77 kg | 114/77 kg |
|  | Overall width | 546 mm | 548 mm | 660 mm | 660 mm |
|  | Length | 915 mm | 950 mm | 1105 mm | 1220 mm |
|  | Overall height | 965 mm | 980 mm | 1015 mm | 950 mm |
|  | Folded length | 1130 mm | 1170 mm | 1220 mm | 1160 mm |
|  | Folded width | 360 mm | 340 mm | 360 mm | 370 mm |
|  | Folded height | 445 mm | 460 mm | 430 mm | 390 mm |

Further measurements at our website

Nice to know

- EZ Rider is Lightweight, portable and folds compactly for the active user. It is suitable for children in need of a functional upright seating position, where the focus is on allowing the child to active and aware of the surroundings.



Accessories



Extended headrest cover
With or without windows (Canopy)
EZ12 C904737/ C904721
EZ14 C904741/ C904725
EZ16 C904742/ C904726
EZ18 C904743/ C904727



Headrest cover
EZ12 C900853
EZ14 C901210
EZ16 C901205
EZ18 C901211

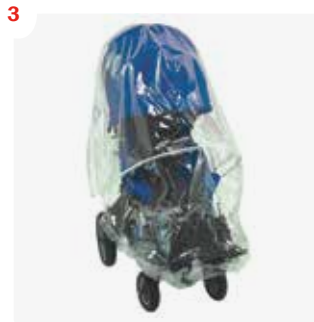

Rain cover and mosquito net
Rain cover: Mosquito net:
12/14 C904939 12/14 C904655
16/18 C904940 16/18 C904656

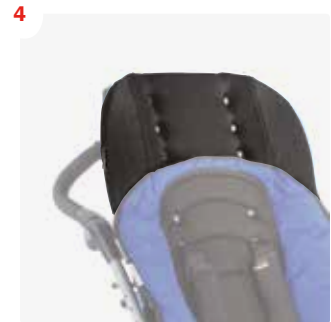

Headrest extension
Curved cordura (black)
EZ12 C902863
EZ14 C900484
EZ16 C900138
EZ18 C902619



Headwings
Padded:
EZ12 C900849
EZ14 C900682
EZ16 C900683
EZ18 C900684



H-harness with padded covers
C903988
3-pt position belt required



3-pt positioning belt
C904017
With depth adjustment croth strap



Full support torso vest
EZ12 C900848
EZ14 C900338
EZ16 C901020
EZ18 C900387

Occi: C904779



Soft lateral support
Single/Double flap
EZ12 C900846/ C900847
EZ14 C900327/ C900650
EZ16 C901018/ C900651
EZ18 C900386/ C900652



Calf panel
C904580



Reducer seat insert
Seat width 5 cm smaller, seat depth 2,5 cm smaller
EZ12 C904211
EZ14-18 C904110



Medial thigh support-abductor
with position/align cushion
EZ12 C900843
EZ14 C900329
EZ16 C901024
EZ18 C900388

13



Lateral thigh support-abductor
with position/align cushion
EZ12 C900844
EZ14 C900330
EZ16 C901026
EZ18 C900389

14



Angle adjustable footplates
EZ12/14 C903268
EZ16/18 C903269

15



Footplate securement strap
C903584

16



Foot positioners
Small (18-25 cm) C903415
Medium (20-28 cm) C903416
Large (23-30 cm) C903417

17



Height adjustable flip-up armrests
EZ12-14 C904523
EZ16-18 C904524

18



Upper extremity support surface
Clear tray
EZ12 C904525
EZ14 C904526
EZ16 C904527
EZ18 C904528

19



Upper extremity support surface
Foam tray
EZ12 C903669
EZ14-16 C903670
EZ18 C903671

20



Anchor transit kit
C997267

21



Anti-tip
EZ12-14 C900377
EZ16-18 C900378

22



Utility bag
C904531

23



Wheelchair travel bag
C902022



User height
700–1700 mm



Max. load
77 kg



Environment
Indoor & outdoor

Rodeo

The Convaid Rodeo is a popular pediatric tilt-in-space wheelchair that is convenient, lightweight and folds compactly. The Rodeo provides up to 45° of adjustable tilt that offers pressure relief and upper body support. This tilt-in-space Rodeo is fully customizable to meet user's specific therapeutic needs and provides growth option through its adjustable seat depth feature.

Highlights about Rodeo



Adjustable tilt and back recline

Provides pressure relief and support.



Customisable growth capabilities

Adjustable seat depth extends chair life for a growing child.



Lightweight and durable

Lightweight frame combined with high Max. load - up to 77 kg.



Individual positioning

Accommodates functional or rest positions and increased sitting tolerance for maximum comfort.



Standard

5 to 45 degrees of adjustable tilt, recline, central mounted foot brake, adjustable one-piece push handle, closure strap, seat depth growth of 13 cm, frontwheels with directional stabilizer, 2-point positioning belt, elevating legrest /one-Piece, angle adjustable footplate.

Options

| | | |
|--|---|--|
| <p>Size:</p> <ul style="list-style-type: none"> - RD12 - RD14 - RD16 | <p>Brake</p> <ul style="list-style-type: none"> - Foot brake - Attendant hand brakes | <p>Tyres</p> <ul style="list-style-type: none"> - Solid - Air - Solid w/transp. fitting - Air w/transp. fitting |
|--|---|--|

Cushion colours



Blue Red Black Pink Purple Green

Frame colour



Silver













Standard Rodeo RD14



Folded Rodeo

Measurements

| | | RD 12 | RD 14 | RD 16 |
|---|---------------------------|--------------|--------------|--------------|
|  | Effective seat width | 305 mm | 355 mm | 405 mm |
|  | Effective seat depth | 230-360 mm | 280-410 mm | 330-460 mm |
|  | Backrest height | 560 mm | 610 mm | 635 mm |
|  | Total mass | 15 kg | 16 kg | 17 kg |
|  | Max. load regular/transit | 34/30 kg | 46/46 kg | 77/64 kg |
|  | Overall width | 580 mm | 630 mm | 680 mm |
|  | Length | 890 mm | 890 mm | 910 mm |
|  | Overall height | 1090 mm | 1120 mm | 1140 mm |
|  | Folded length | 860 mm | 860 mm | 1015 mm |
|  | Folded width | 585 mm | 635 mm | 685 mm |
|  | Folded height | 430 mm | 460 mm | 460 mm |

Further measurements at our website

Nice to know

- Rodeo is suitable for walks in uneven terrain and nature.
- It is easy to adjust most of the settings and it is possible to use it for different children.



Accessories



Extended Headrest cover
With or without windows (Canopy)
12 C904745/ C904729
14 C904746/ C904730
16 C904747/ C904731



Rain cover and Mosquito net
Rain cover: Mosquito net:
12/14 C904939 12/14 C904655
16 C904940 16 C904656



Headrest Extension
Required for transit model
12 C902863
14 C900484
16 C900138



Headwings
Padded:
12 C902673
14 C902653
16 C903147
Occ: C904779



H-harness with padded covers
With padded covers
C903988



3-pt positioning belt
With adjustable crotch strap
C904017



Full torso vest
12 C903261
14 C903260
16 C903259



Reducer seat insert
Seat width 5 cm smaller, seat depth 2,5 cm smaller.
12 C904211
14 C904110



Swing away laterals - contoured
X-small C902980
Small C902981
Medium C902982
Large C902983



Cushions
Support, position and align cushion available.
12 C904350 / C904351 / C904352
14 C904353 / C904354 / C904355
16 C904356 / C904357 / C904358



Calf panel
C904361



Thigh support
Lateral: Medial:
12 C903668 12 C902668
14 C903648 14 C902647
16 C903141 16 C903140



Foot positioners
 Small (18-25 cm) C903415
 Medium (20-28 cm) C903416
 Large (23-30 cm) C903417



Legrest extension
 12 C904095
 14 C904096
 16 C904097



Height adjustable flip-up armrest
 C904346



Solid/Mesh side panels
 12 C902672/ C902680
 14 C902652/ C902681
 16 C903145/ C903146



Rear anti-tip tubes (pair)
 C904649



Upper extremity support surface (clear tray)
 Flip-up arm rest required
 12 C903405
 14 C903401
 16 C903402



Upper extremity support tray
 Foam tray
 12 C903669
 14/16 C903670

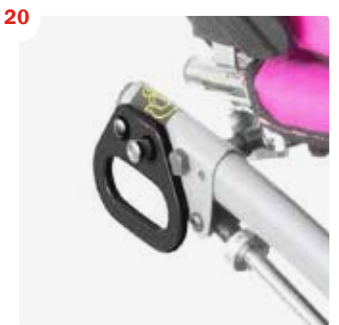

Anchor transit kit
 C997124



Medical necessity storage
 12 C904476
 14/16 C904477



Under seat storage basket
 12 C904529
 14/16 C904530

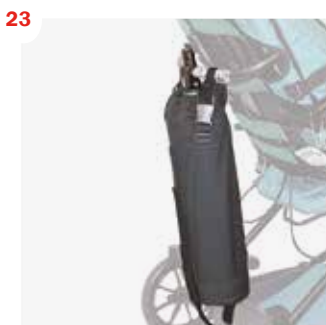

Oxygen tank bag
 C902870



Utility bag
 C904531



Overall width
560-620 mm



Max. load
60-100 kg



Environment
Indoor & outdoor*

*Only High-low Frame outdoor version for outdoor use.

High-low Frame[®]

The High-low Frame is a stable base with a user friendly height adjustment from floor to table height.

The High-low Frame is available either as an indoor frame with small lockable castors or as an outdoor frame with large wheels and foot brake.

Highlights about High-low Frame



Height adjustment

The height is adjustable from floor to table height. The frame are available with either gas or power height adjustment.



Interface

Various seats can be mounted on the High-low Frame by means of an interface. Here a High-low Frame for outdoor mounted with a Panda Futura.



Angling of seat base

The seat base has an angle range of 40° which helps obtain varied seating positions. The base can be set to angle from 0° to 30° or from -10° to 20°.



Safe transportation in vehicles

The High-low Frame, outdoor, complies with the international transit wheelchair standard ISO 7176-19. The High-low Frame, outdoor, can be used with seat units that comply with ISO 16840-4.



Standard

Height adjustment, angling of seat plane, one size outdoor frame with 12 1/2" rear wheels 7" swivel front wheels and foot brake, one size indoor with 100 mm lockable castors.

Options

- Indoor frame**
- Gas
 - Power

- Outdoor frame**
- Gas
 - Power
 - Handbrakes
 - Handbrakes and power

Frame colour



Black

Accessories

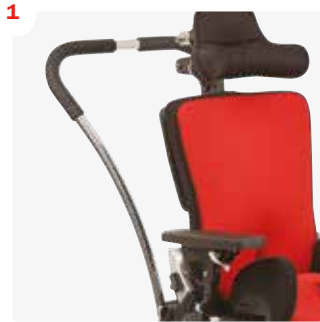

Push brace for indoor High-low
89105x5

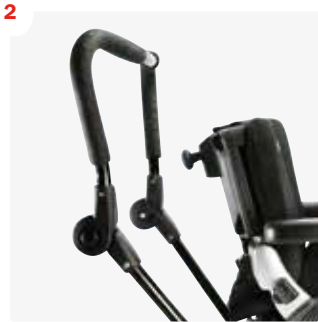

Angle adjustable push brace for indoor frame
8910565, 8910555

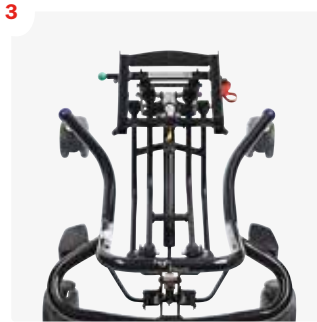

Extra gas spring
89955+8911003



Anti-tip for High-low
89951-0x



Power kit for High-low
8995x



Rod for foot support
Double rod: 891084x-x
Single rod: 891082x-x

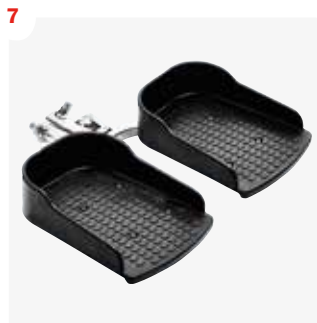

Parted foot supports
89146-x



Foot plate
95145-1, 85145-2

For more accessories - visit our website

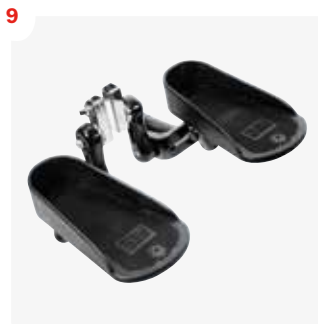

Individual angle adjustable foot supports
89143-x



Foot plate model Wombat
95145-2, 95145-3, 95145-4

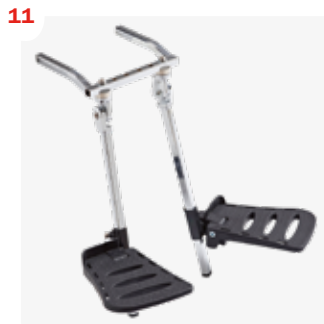

Individual multi adjustable foot support
Size 1 8910851-x
Size 2+3 8910852-x



Adjustable legsupport
89162



Foot plate
89130



Foot plate, padded
89128



Transport fittings only for outdoor frames
9809xx



Wheels with directional stabilizers
89592-KIT

Measurements

| | | Indoor Frame | | Outdoor Frame | |
|--|------------------------------------|--------------|------------|---------------|------------|
| | | w/Gas | w/Power | w/Gas | w/power |
| | Seat surface height at front edge* | 170-600 mm | 260-700 mm | 260-700 mm | 260-700 mm |
| | Max. Load | 60 kg | 60 kg | 60 kg | 60 kg |
| | Max. load at transportation | - | - | 43 kg | 43 kg |
| | Seat plane angle | -10° - 30° | -10° - 30° | -10° - 30° | -10° - 30° |
| | Length | 690 mm | 690 mm | 960 mm | 960 mm |
| | Overall width | 560 mm | 560 mm | 620 mm | 620 mm |
| | Total mass | 12,5 kg | 13 kg | 17,5 kg | 18,0 kg |

*measured to adaptor plate Further measurements at our website



Overall width
560-620 mm



Max. load
60-100 kg



Environment
Indoor & outdoor*

*Only High-low:x Frame outdoor version for outdoor use.

High-low:x Frame[®]

The High-low:x Frame is a stable base with a user friendly height adjustment from floor to table height.

The High-low:x Frame is available either as an indoor frame with small lockable castors or as an outdoor frame with large wheels and foot brake.

Highlights about High-low:x Frame



Height adjustment

The height is adjustable from floor to table height. The frames are available with either gas, power or hydraulic height adjustment.



Fixed mounting or interface

On the High-low:x size 1 and 2 the seats are mounted into the interface. On size 3 the seats can be mounted either directly onto the High-low:x Frame or by using an interface.



Angling of seat base

The seat base has an angle range of 40° which helps obtain varied seating positions. The base can be set to angle from 0° to 30° or from -10° to 20°.



Safe transportation in vehicles

The High-low:x Frame, outdoor, complies with the international transit wheelchair standard ISO 7176-19. The High-low Frame, outdoor, can be used with seat units that comply with ISO 16840-4.



Standard

Height adjustment, angling of seat plane, 2 sizes outdoor frame with 12 ½" rear wheels 7" swivel front wheels and foot brake, 3 sizes indoor with 100 mm lockable castors.

Options

Height adjustment

- Gas
- Power
- Hydraulic

Seat mounting

- Adaptor plate
- Fixed mounting on seat plate (Only for size 3 indoor)

Frame colour



Black









Standard High-low:x Frame with gas









High-low:x Frame mounted with x:panda

Measurements

| High-low:x indoor | | 1 gas | 2 gas | 1 power | 2 power | 3 power | 2 hydraulic |
|---|------------------------------------|------------------|------------------|--------------------|--------------------|--------------------|------------------------|
|  | Seat surface height at front edge* | 170-600 mm | 250-610 mm | 170-600 mm | 250-620 mm | 320-560 mm | 220-580 mm |
|  | Max. load | 60 kg | 60 kg | 60 kg | 60 kg | 100 kg | 60 kg |
|  | Seat plane angle | -10°- 30° | -10°- 30° | -10°- 30° | -10°- 30° | -10°- 30° | -10°- 30° |
|  | Length | 690 mm | 780 mm | 690 mm | 780 mm | 780 mm | 780 mm |
|  | Overall width | 560 mm | 620 mm | 560 mm | 620 mm | 620 mm | 620 mm |
|  | Total mass | 12,5 kg | 14,0 kg | 13,0 kg | 16,5 kg | 17,0 kg | 16,5 kg |

*To adaptor plate Further measurements at our website

| High-low:x outdoor | | 1 gas | 2 gas | 1 power lift | 2 power lift | 2 hydraulic |
|---|------------------------------------|------------------|------------------|-------------------------|-------------------------|------------------------|
|  | Seat surface height at front edge* | 260-700 mm | 330-640 mm | 260-700 mm | 330-640 mm | 430-590 mm |
|  | Max. load | 60 kg | 60 kg | 60 kg | 60 kg | 60 kg |
|  | Max. Load at transportation | 43 kg | 43 kg | 43 kg | 43 kg | 43 kg |
|  | Seat plane angle | -10°- 30° | -10°- 30° | -10°- 30° | -10°- 30° | -10°- 30° |
|  | Length | 960 mm | 1110 mm | 960 mm | 1110 mm | 1110 mm |
|  | Overall width | 620 mm | 620 mm | 620 mm | 620 mm | 620 mm |
|  | Total mass | 17,5 kg | 20,0 kg | 18,0 kg | 20,5 kg | 20,5 kg |

*To adaptor plate Further measurements at our website

Nice to know

Recommendations for the choice of frame.

Stingray seat size 1 or 2: Frame size 2
 x:panda size 1-2: Frame size 1
 x:panda size 3: Frame size 2 or 3
 x:panda size 4: Frame size 3

How to calculate the load on the frame:

User (weight of child) + Seat + accessories = Load

Example: Child (25 kg), x:panda size 2 (8.5 kg),
 Accessories (5 kg), Total: 38.5 kg.



Accessories



Push brace for indoor High-low:x
8910545

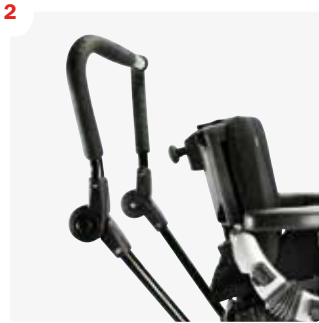

Angle adjustable push brace for indoor frame
8910565, 8910555



Foot pedal kit
8910610

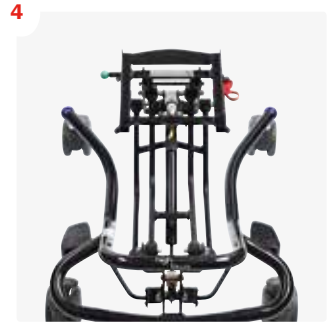

Extra gas spring
89955+8911003



Power kit for High-low:x
9896x

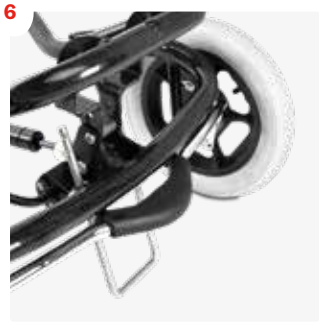

Anti-tip for High-low:x
89951-0x



Transport fittings only for outdoor frames
9809xx

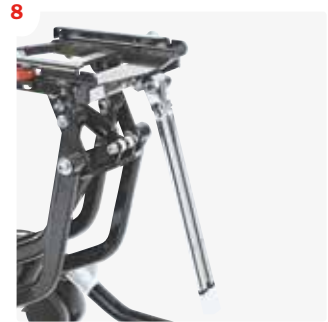

Double rod for foot support
891084x-x

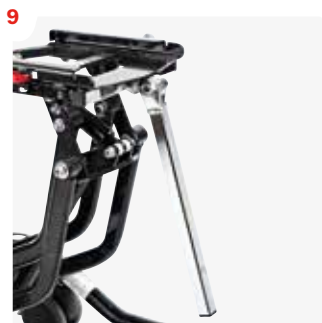

Single rod for foot support
891082x-x

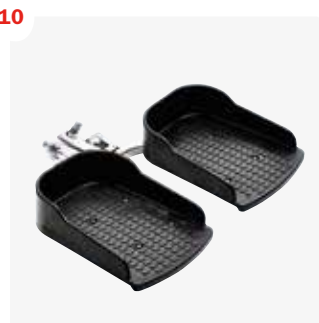

Parted foot supports
89146-x



Foot plate
95145-1, 85145-2



Individual angle adjustable foot supports
89143-x

For more accessories - visit our website

13



Individual multi adjustable foot support
Size 1 8910851-x
Size 2+3 8910852-x

14



Adjustable legsupport
89162

15



Foot plate model Wombat
95145-2, 95145-3, 95145-4

16



Foot plate
89130

17



Foot plate, padded
89128

18



Wheels with directional stabilizers
89592-KIT

19



Central brake kit
8910950





Overall width
590-690 mm



Max. load
100 kg



Environment
Indoor & outdoor

Multi Frame[®]

The Multi Frame is an innovative, lightweight and highly manoeuvrable wheelchair base designed to fit both the Panda Futura and x:panda, but also other manufacturers seating that is constructed in a similar fashion and meets the current standards.

Highlights about Multi Frame



Tilt in space

Simple to operate tilt in space with the minimum of moving parts.



Seats

Mount a Panda Futura or x:panda seat on the Multi Frame.



Prepared for other manufactures seats and backs

Mount a Panda Futura or x:panda seat on the Multi Frame.



Safe transportation in vehicles

The Multi Frame complies with ISO 7176-19, transporting users in motor vehicles. The Multi Frame can be used with seat units that complies with ISO 16840-4.



Standard

3 sizes, built-in tilt in space 0 to 30°, change of seat to floor height, brakes, anti tips - swing away type, angle adjustable push brace.

Options

Three sizes

- Size 1
- Size 2
- Size 3

Seat mounting

- Fixed mounting on seat plate (standard)
- Adaptor plate

Rear wheels

- 12 ½" solid or air
- 22" solid or air

Brakes

- Wheel brake
- Drum brake

Front wheels

- 7" solid grey or black
- 7" air grey or black

Framecolour



Silver



















Multi Frame with 12.5" rear wheels



Multi Frame with 22" rear wheels

Measurements

| | | 1 | 2 | 3 |
|---|------------------------------------|------------------|------------------|------------------|
|  | Seat surface height at front edge* | 395, 425, 455 mm | 395, 425, 455 mm | 395, 425, 455 mm |
|  | Max. Load | 100 kg | 100 kg | 100 kg |
|  | Max. load at transportation | 100 kg | 100 kg | 100 kg |
|  | Seat plane angle | 0-30°, 35°, 40° | 0-30°, 35°, 40° | 0-30°, 35°, 40° |
|  | Width between wheels | 340 mm | 390 mm | 440 mm |
|  | Length 12½" | 640 mm | 640 mm | 690 mm |
|  | Length 22" | 750 mm | 750 mm | 800 mm |
|  | Overall width | 590 mm | 640 mm | 690 mm |
|  | Overall height** | 915 mm | 915 mm | 915 mm |
|  | Folded length 12½" | 730 mm | 730 mm | 780 mm |
|  | Folded width 12½" | 470 mm | 470 mm | 470 mm |
|  | Folded height 12½" | 640 mm | 640 mm | 690 mm |
|  | Folded length 22" | 850 mm | 850 mm | 900 mm |
|  | Folded width 22" | 590 mm | 640 mm | 690 mm |
|  | Folded height 22" | 560 mm | 560 mm | 560 mm |
|  | Total mass 12 ½" wheels | 13 kg | 13 kg | 13 kg |
|  | Total mass 22" wheels | 14 kg | 14 kg | 14 kg |

*measured to basic plate **measured with push brace 15° Further measurements at our website



Accessories



1
Interface
8911610-98 + 8911610-99



2
Transport fittings
970905

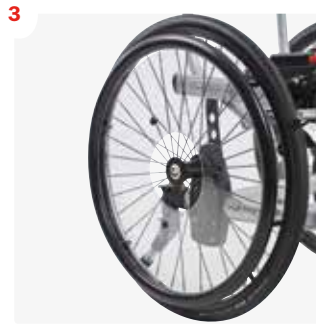

3
Spoke protector
970922

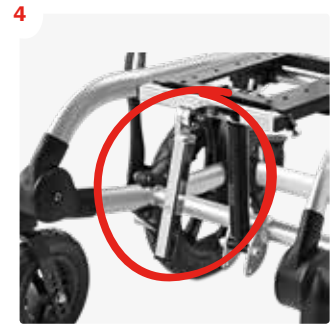

4
Single rod for footsupport
8910821-x



5
Individual multi adjustable foot support
8910852-x



6
Foot plate
95145-1, 85145-2



7
Foot plate model Wombat
95145-2, 95145-3, 95145-4



8
Vent tray
970815

For more accessories - visit our website

Nice to know

The angle of the push brace can be adjusted to make a bigger distance between the push brace and seat. The adjustment is easily done with the use of the strap under the frame and the correct position is easily recognized by the click of the locking pin into the fitting.





Overall width
660 mm



Max. load
100 kg



Environment
Indoor & outdoor

Multi Frame:x[®]

Designed to provide extraordinary stability and safety, the Multi Frame:x is the perfect choice of wheelchair base for large seat units like the Panda Futura 5 and x:panda 4. The Multi Frame:x is a strong, stable and highly manoeuvrable wheelchair base.

Highlights about Multi Frame:x



Seats for Multi Frame:x

Multi Frame:x is the perfect choice of wheelchair base for large seat units like the Panda Futura 5 and x:panda 4 from R82.



User-friendly adjustability

The tilt-in-space and back recline functions are operated from the push brace ensuring optimum working conditions. Stepless recline of the push handle makes it possible to adapt the height to any carer.



Seat height adjustment

Positioning the user as close to the floor as possible ensures a much easier transfer.



Tested and approved

The Multi Frame:x complies with ISO 7176-19, transporting users in motor vehicles. The Multi Frame:x can be used with seat units that comply with ISO 16840-4.



Standard

Built-in recline, built-in tilt, anti-tip device, seat height adjustment, angle adjustable push brace.

Options

Rear wheels

- 12 ½" solid or air
- 20"/22"/24" solid or air

Front wheels

- 6" solid
- 7" solid or air

Brakes

- Wheel brake
- Drum brake

Framecolour



Anthracite grey











Multi Frame:x with 12 ½" rear wheels and 7" front wheels



Multi Frame:x with 22" rear wheels and 6" front wheels

Measurements

| | | 3 |
|---|-----------------------------------|------------------|
|  | Seat surface height at front edge | 410, 435, 460 mm |
|  | Max. Load | 100 kg |
|  | Max. load at transportation | 100 kg |
|  | Seat plane angle | -5-30° |
|  | Width between wheels | 215 x 405 mm |
|  | Length | 840 mm |
|  | Overall width | 660 mm |
|  | Overall height | 980 mm |
|  | Total mass | 20 kg |

The Multi Frame:x is approved for transporting users in motor vehicles. Secure the user with an approved 3-point belt according to ISO 10542-1 and use an approved 4-point strap-type tiedown system according to ISO 10542-2 to secure the wheelchair in a forward-facing position in the vehicle. All removable accessories must be dismantled and secured separately in the vehicle.

Nice to know

Use the seat height adjustment to position the user as close to the floor as possible for easier transfer – or use the seat height extension to increase the distance from the frame to the floor to 460 mm, which allows for customisation for users with longer legs.



Accessories



Adapter
8911610-99L



Mud guards
96052x

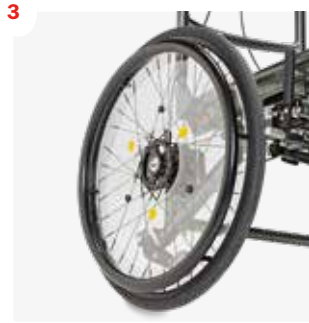

Spoke protector
9709xx



Seat height extension
961030-xx



Mounting for foot rest system
9610421

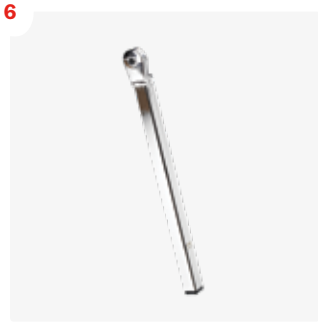

Single rod for foot rest
897526x



Foot plate model Wombat
95145-2, 95145-3, 95145-4



Foot plate
95145-1, 85145-2



Calf support
85131

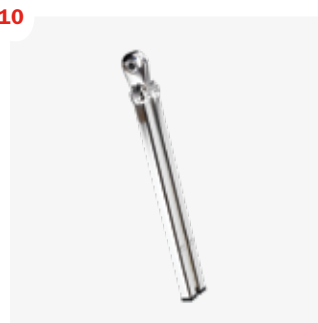

Double rod for foot rest
897528x



Parted foot supports
89146-x



Individual angle adjustable foot supports
89143-x

For more accessories - visit our website

13



Parted foot rests
9610420

14



Transport fittings
960905

15



Vent tray
95281-10





Overall width
590 mm



Max. load
40 kg



Environment
Indoor & outdoor

Stingray Frame[®]

The Stingray frame with 180° turntable base makes it possible to move your child from forward to rearward facing without leaving their seat.

The carbon Stingray Frame is in a league of its own with the trendsetting design, great adjustments and ease of steering.

Highlights about Stingray Frame



180° turnable seat unit

Revolutionary function with a 180° turntable seat unit. Let your child explore the surroundings during the trip or simply turn the unit to obtain eye contact with your child.



Foldable frame

The Stingray Frame is foldable for storage and transportation.



Tilt in space

The tilt in space function is very useful when the user needs to rest. Simply angle the complete unit into the desired position.



Safe transportation in vehicles

The Stingray Frame complies with the international transit wheelchair standard ISO 7176-19. The Stingray Frame can be used with seat units that comply with ISO 16840-4.



Standard

180° degree turntable base, one size with 12" rear wheels, tilt-in-space, adaptor plate.

Options

| | | | |
|---|--|--|---|
| <p>Front wheels</p> <ul style="list-style-type: none"> - 12" solid or air, no swivel - 7" solid or air, turnable front wheels, with directional stabilizer | <p>Foot brake</p> <ul style="list-style-type: none"> - Individual - Central | <p>Hand brake</p> <ul style="list-style-type: none"> - Hand brakes - No hand brakes | <p>Foot rest</p> <ul style="list-style-type: none"> - Long bar - Short bar |
|---|--|--|---|

Frame colour



Black

Accessories



Shopping basket
8720600



Transport fittings
8720902



Vent tray
8776290



Oxygen bottle holder
8776295

For more accessories - visit our website



Standard Stingray with 12" no swivel front wheels



Standard Stingray with 7" turnable front wheels, with directional stabilizer

Measurements

| | | 1 |
|--|-------------------------------------|---------------------|
| | Seat surface height at front edge** | 520 mm |
| | Max. Load | 40 kg |
| | Max. load at transportation | 40 kg |
| | Seat plane angle | 170° |
| | Length* | 740 mm |
| | Overall width | 590 mm |
| | Overall height | 1000, 1030, 1060 mm |
| | Folded length | 900 mm |
| | Folded width | 590 mm |
| | Folded height | 490 mm |
| | Total mass | 20 kg |

*Measured with turnable front wheels ** Measured to adaptorplate Further measurements at our website



Standard Stingray with 7" turnable front wheels, mounted with x:panda seat





Overall width
580-730 mm



Max. load
100 kg



Environment
Indoor & outdoor

Combi Frame:x[®]

The Combi Frame:x is a unique wheelchair frame for customized seating systems. The Combi Frame:x is ideal for both indoor and outdoor use and can be fitted with different seat and back systems. The Combi Frame:x is suitable for users needing an individual seating system and base.

Highlights about Combi Frame:x



Centre of gravity and tilt in space

The Combi Frame:x centre of gravity is self-centring. The seating unit can be tilted from horizontal to 40 degrees.



Compatible with different seat and back systems

The Combi Frame:x can be equipped with different back systems and cushions.



Fixed mounting or interface

Various seats can be mounted directly onto the Combi Frame:x. Alternatively the seats can be mounted into an interface. The frame is used for a variety of seating units like the Panda Futura and x:panda from R82.



Safe transportation in vehicles

The Combi Frame:x complies with the international transit wheelchair standard ISO 7176-19. The Combi Frame:x can be used with seat units that comply with ISO 16840-4.



Standard

4 sizes, self-centring centre of gravity, prepared for x:panda, Panda and moulded seats, anti-tip device.

Options

| | | | | | |
|---|--|--|---|--|---|
| Four sizes <ul style="list-style-type: none">- Size 1- Size 2- Size 3- Size 4 | Seat mounting <ul style="list-style-type: none">- Fixed mounting on seat plate (standard)- Adaptor plate | Rear wheels <ul style="list-style-type: none">- 12 ½" solid or air- 20"/22"/24" solid or air | Front wheels <ul style="list-style-type: none">- 6" solid or air- 7" solid or air | Back recline <ul style="list-style-type: none">- No recline- Recline | Brakes <ul style="list-style-type: none">- Wheel brake- Drum brake- Wheel brake + drum brake |
|---|--|--|---|--|---|

Frame colour



Silver Black White



Combi Frame:x with 12½" wheels



Combi Frame:x with 24" wheels

Measurements

| | | 1 | 2 | 3 | 4 |
|---|-----------------------------------|------------------|------------------|------------------|------------------|
|  | Seat surface height at front edge | 430, 460, 490 mm | 430, 460, 490 mm | 430, 460, 490 mm | 430, 460, 490 mm |
|  | Max. Load | 100 kg | 100 kg | 100 kg | 100 kg |
|  | Max. load at transportation | 100 kg | 100 kg | 100 kg | 100 kg |
|  | Seat plane angle | 0-40° | 0-40° | 0-40° | 0-40° |
|  | Width between wheels | 440 mm | 490 mm | 560 mm | 600 mm |
|  | Length | 830 mm | 830 mm | 830 mm | 830 mm |
|  | Overall width | 580 mm | 630 mm | 680 mm | 730 mm |
|  | Overall height | 900 mm | 940 mm | 1040 mm | 1140 mm |
|  | Folded length | 800 mm | 800 mm | 840 mm | 940 mm |
|  | Folded width | 580 mm | 630 mm | 680 mm | 730 mm |
|  | Folded height | 550 mm | 550 mm | 550 mm | 550 mm |
|  | Total mass | 22 kg | 23 kg | 24 kg | 27 kg |

Further measurements at our website

Nice to know

The Combi Frame:x is a unique wheelchair frame for customised seating systems. The multiple adjustment possibilities and the large accessories selection allows for a highly customised seating solution for the individual user with complex needs.

The kit for dynamic back rest with recline provides dynamic movement of the back rest. A dynamic back allows the user to push back during the extensor trust and supports the user to regain the starting point for the movement.



Accessories



Mounting for head support
980200

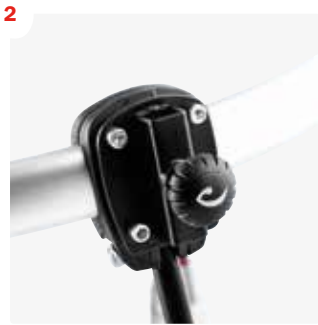

Mounting for head support
9802x0

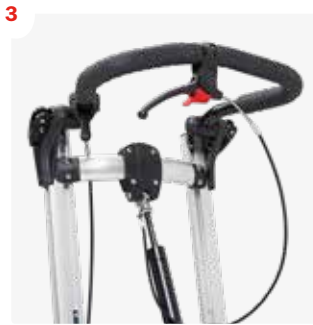

Kit for dynamic back rest with recline
980946-DYN



Fix locks
970710

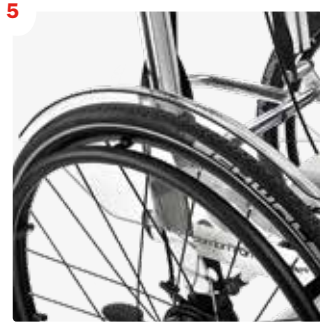

Mudguards
98052x-1

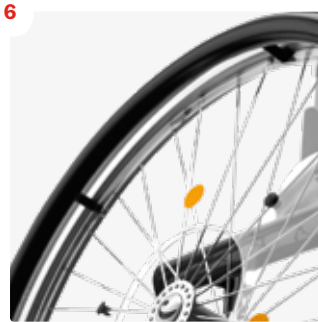

Spoke protectors
97102x

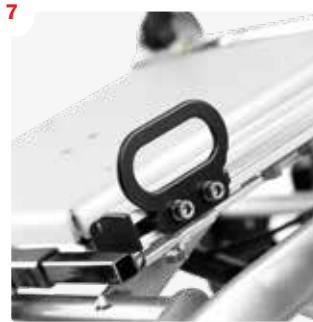

Transport fittings
980900, 980903



Adapter
8911610-98 + 8911610-99



Mounting for single/parted foot support
98015x



Single rod for foot rest
897526x



Bar for parted foot support
897528x



Individual angle adjustable foot supports
89143-x

For more accessories - visit our website

13



Foot support
89144-x01

14



Parted foot supports
89146-x

15



Foot plate model Wombat
95145-2, 95145-3, 95145-4

16



Foot plate
95145-1, 85145-2

17



Leg rest with gas strut
970500-x

18

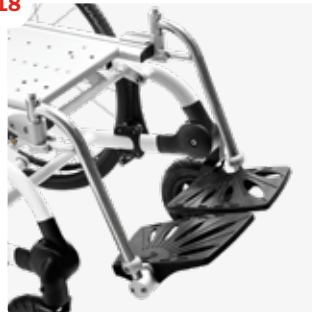

Fixed angle leg rest
970510-x

19

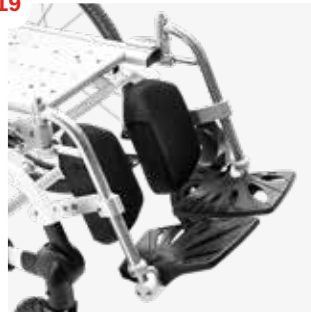

Calf supports, parted incl. cover
970550-x

20

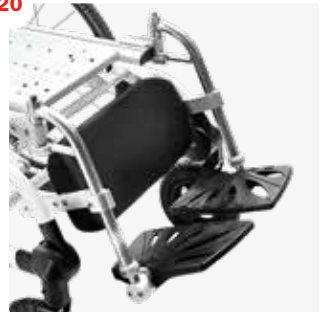

Calf support, one piece incl. cover
970555-x

21



Extra cover for calf support
970550-x13, parted
970555-x13, one piece

22

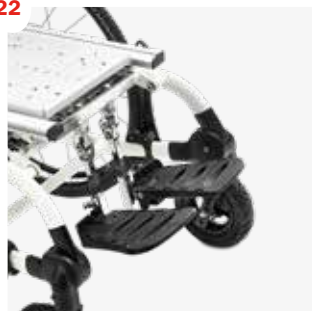

Individual, multi-adjustable foot support
981085x-x

23

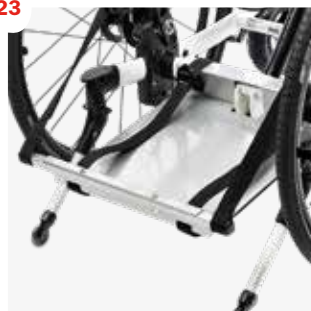

Vent tray
970815

24

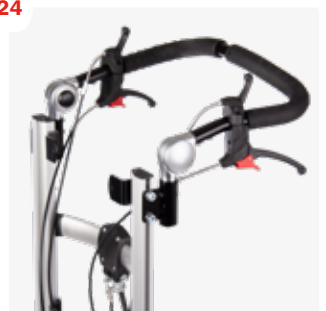

Push brace, complete
(Supplied as standard for Combi Frame:x as of 1st January 2019)
97054x-1



Overall width
600 mm



Max. load
120 kg



Environment
Indoor only

Strong Base[®]

The Strong Base is a simple, stable and sturdy base for large seat units such as the Panda Futura 5 and the x:panda 4.

Seat units are mounted either directly onto the Strong Base or by means of an interface making it easy to switch between frames.

Highlights about Strong Base



Height adjustment

The Strong Base has either manual or spindle height adjustment. The manual base adjust from 30 to 55 cm in height - the spindle base adjust from 30 to 51 cm in height.



Tilt in space

The tilt in space function helps obtain varied seating positions. Simply angle the complete unit into the desired position. Tilt in space from -10 to +25°.



Fixed mounting or interface

Various seats can be mounted directly onto the Strong Base. Alternatively the seats can be mounted by means of an interface.



Easy to manoeuvre

The smooth running castors make it very easy to move the Strong Base around. All four castors are equipped with directional stabilizers and brakes.



Standard

1 size in 2 versions, built-in tilt in space, 125 mm swivel castors with brakes and directional stabilizers, lock on all 4 wheels, seat plate.

Options

Seat mounting

- Seat plate (standard)
- Adapter plate

Height adjustment

- Manual
- Spindle

Frame colour



Anthracite grey

Accessories

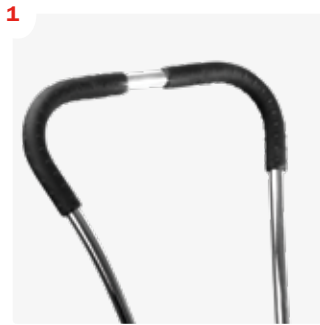

Push brace
89105x5



Angle adjustable push brace for indoor frame
872083x



Adapter for seat mounting
8911610-99L



Single rod for foot supports
891082x-x



Double rod for foot supports
891084x-x

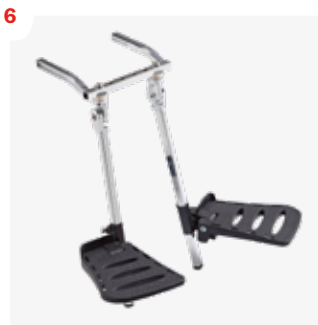

Individual multi adjustable foot support
Size 1 8910851-x
Size 2+3 8910852-x



Individual angle adjustable foot supports
89143-x



Wombat foot plate
95145-3, 95145-4

For more accessories - visit our website

9



Parted foot supports
89146-x

10



Width extension for multi-adjustable foot support
8910855

Measurements

| | | 1 | 2 |
|--|------------------------------------|------------|------------|
| | Seat surface height at front edge* | 420-670 mm | 420-630 mm |
| | Max. Load | 120 kg | 120 kg |
| | Seat plane angle | -10°-25° | -10°-25° |
| | Length | 700 mm | 700 mm |
| | Overall width | 600 mm | 600 mm |
| | Overall height | 300-550 mm | 300-510 mm |
| | Total mass | 14 kg | 15,5 kg |

*Measured from x:panda 4 seat to floor Further measurements at our website

Nice to know

The Panda Futura 5 or x:panda size 4 is mounted directly onto the Strong Base or by means of an interface making it possible to switch the seat between frames.

The seat surface height at the front edge of the x:panda size 4 on 420 mm allows standing transfers into the seat.



Standing, overview

| | | Meerkat | Rabbit Up | Toucan | Caribou | Gazelle |
|--------------|--|-------------|--------------|--------------|-------------|-------------|
| Target users | Max. load | 90 kg | 70 kg | 70 kg | 100 kg | 80 kg |
| | User height | 700–1800 mm | 1000–2000 mm | 1000–2000 mm | 850–1840 mm | 700–1350 mm |
| Features | Easy transfer using the tilt function | | | | • | • |
| | Accessories are easily interchangeable | • | | | • | |
| | Mobile (Quick release wheels) | | • | | | |
| | Hip abduction (0–30°) | | | | | • |
| | Dynamic standing | • | | | | |
| Environment | Indoor | • | • | • | • | • |
| | Outdoor | | • | | | |



Standing

**Safe support while standing increases both
physical and mental well-being!**



User height
700-1800 mm



Max. load
90 kg



Environment
Indoor only

Meerkat[®]

The Meerkat is a simple and modular built standing frame with a free choice of positioning in anterior or posterior.

The Meerkat is available in 3 sizes and suitable for children and youngsters.

Highlights about Meerkat



Dynamic standing

The child's freedom of movement is encouraged with minimal support, pure product design and the innovative rocker.



Simple and intuitive

All support is intuitively easy to use and adjust, making life easier for parents and carers. The low entrance height ensures easy transfer.



Easy adjustments

Simple adjustments can be done without any tools required. The child can have fun and play while standing.



Growth adjustable accessories

Growth opportunity and increased reuse possibility.



Standard

Base plate with wheels, column, tool.

Options

Size

- Size 1
- Size 2
- Size 3

Base plate colours and castors



Strawberry ice with cow,
size 1



Pastel blue with airplane,
size 1

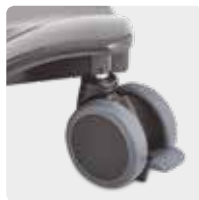







Anthracite with grey,
size 2+3



The Meerkat comes with column, base plate and tool for all sizes

Measurements

| | | 1 | 2 | 3 |
|---|----------------------------|-------------|-------------|--------------|
|  | User height: floor to axil | 400–750 mm | 720–1000 mm | 840–1300 mm |
|  | User height | 700–1050 mm | 950–1350 mm | 1170–1800 mm |
|  | Max. load | 20 kg | 65 kg | 90 kg |
|  | Length | 595 mm | 800 mm | 800 mm |
|  | Overall width | 525 mm | 780 mm | 780 mm |
|  | Overall height | 375–750 mm | 500–1000 mm | 650–1300 mm |
|  | Total mass | 9 kg | 15 kg | 15 kg |

Further measurements at our website

Nice to know

The Meerkat can be used to create a learning environment, where the chest, pelvic and knee supports are used to provide the child with the exact support needed to challenge static and active trunk control. When the Meerkat is fitted with a rocker, it is possible to challenge the child's reactive trunk control.

When the child develops control over a segment of the trunk, the support can gradually be moved from top down.

Thereby the Meerkat allows the child to develop trunk control, as seen in typically developing children, which might lead to improvement in gross motor function and mobility.



Accessories



Chest support
86948x



Pelvic support
86924x



Knee supports
86984x



Sandals
86949x-x



Rocker
118598-1, 117047-1



Tray
869485



Displacement kit
124025



Daily adjustment kit
124026



Simple and effective standing

Provides more freedom to move and encourages the child to keep an active upright posture.

For more accessories - visit our website

Easy & fun

Mounting of the rocker can be done while the child is standing in the Meerkat.





User height
1000–2000 mm



Max. load
70 kg



Environment
Indoor & outdoor

Rabbit[®] Up

The Rabbit Up is a truly adaptable stander. It is secure, reliable and adjustable for all standing needs while also offering the independence to explore using the optional driving wheels. The Rabbit Up enables the child to be an active participant whilst stimulating senses and providing the child with more independence.

Highlights about Rabbit Up



Stander and Mobile stander

The Rabbit Up not only meets all your standing needs but also offers its users the freedom and opportunity to explore using the two optional driving wheels, giving additional independence to the child.



Angle adjustable centre bar

The Rabbit Up has two simple, easy to use angle adjustment options: fixed positions and stepless spindle. This makes transfer easier and helps obtain the best possible position for standing and propelling the driving wheels.



Quick release wheels

The two driving wheels are equipped with quick release for easy mounting and dismounting. The wheels are available in a variety of sizes from 22" up to 36" so you can find the perfect fit for the child.



Camber angling

If you choose to use the driving wheels on your Rabbit Up you have the possibility to change the camber angle. This enables an optimum position of the driving wheels, making propelling easier for the child.



Standard

Mobile stander: Frame, center bar, two driving wheels, standard camber angle, four castors, spoke protectors, fixed positions angle adjustment. Standing frame: Frame, center bar, four castors with brakes.

Options, Mobile stander

| | | | | | |
|---|--|---|--|---|--|
| <p>Four sizes</p> <ul style="list-style-type: none"> - Size 1 - Size 2 - Size 3 - Size 4 | <p>Driving wheels</p> <ul style="list-style-type: none"> - 22" 24" - 26" 29" - 32" 36" | <p>Standard camber angle</p> <ul style="list-style-type: none"> - Size 1: 8° - Size 2+3: 6° - Size 4: 4° <p>Standard plus</p> <ul style="list-style-type: none"> - +3°, +6°, -3°, -6° | <p>Push rims</p> <ul style="list-style-type: none"> - Open - Closed | <p>Castors</p> <ul style="list-style-type: none"> - With brakes - Without brakes (driving wheels must be fitted) | <p>Angle adjustment</p> <ul style="list-style-type: none"> - Fixed positions (standard) - Spindle |
|---|--|---|--|---|--|

Options, Standing frame

| | | |
|---|---|--|
| <p>Four sizes</p> <ul style="list-style-type: none"> - Size 1 - Size 2 - Size 3 - Size 4 | <p>Brakes</p> <ul style="list-style-type: none"> - 4 castors with brakes (standard) - Prepared for driving wheels, 4 castors with brakes | <p>Angle adjustment</p> <ul style="list-style-type: none"> - Fixed positions (standard) - Spindle |
|---|---|--|

Frame colours



Yellow for size 1



Blue for size 2



Anthracite grey for size 3



Silver for size 4





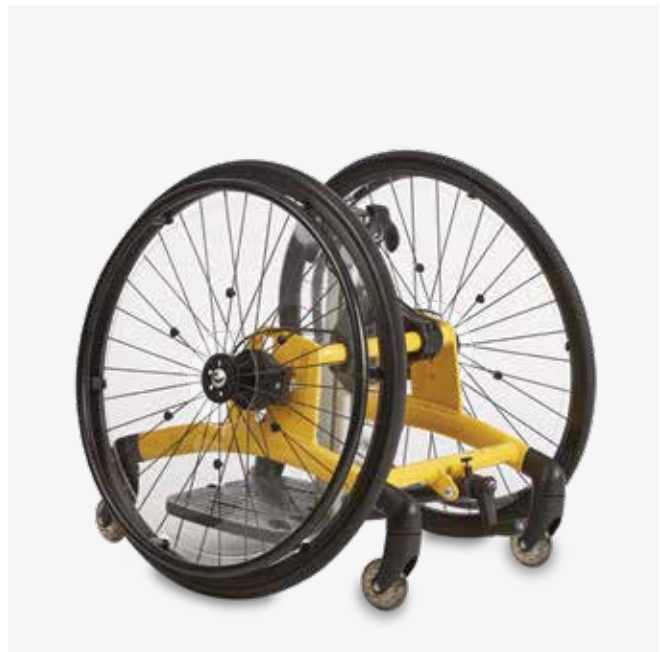







Standard Standing Rabbit Up size 1 (foot plate not standard)



Standard Mobile Rabbit Up size 1 (foot plate not standard)

Measurements

| | | 1 | 2 | 3 | 4 |
|--|-------------------------------------|-------------|-------------|-------------|--------------|
|  | User height: floor to axil | 550–740 mm | 750–1080 mm | 830–1190 mm | 960–1420 mm |
|  | Max. load | 40 kg | 50 kg | 60 kg | 70 kg |
|  | Angling | 0–30° | 0–30° | 0–30° | 0–30° |
|  | Length | 700 mm | 796 mm | 796 mm | 926 mm |
|  | Length, with driving wheels* | 620 mm | 750 mm | 800 mm | 900 mm |
|  | Overall width | 515 mm | 500 mm | 600 mm | 600 mm |
|  | Overall width, with driving wheels* | 635 mm | 680 mm | 730 mm | 720 mm |
|  | Overall height | 670–1000 mm | 850–1180 mm | 990–1310 mm | 1200–1530 mm |
|  | Total mass | 9 kg | 10.5 kg | 11 kg | 13.5 kg |
|  | Total mass, with driving wheels* | 13,5 kg | 15,5 kg | 16 kg | 18,5 kg |

Further measurements at our website
The Rabbit Up is measured in an upright position, without driving wheels and with the foot plate in lowest position
*With driving wheels: size 1 with 22", size 2 with 26", size 3 with 32", size 4 with 36" wheels

Nice to know

Rabbit UP offers the child the possibility to independently explore their surroundings by moving around using the optional driving wheels – and maybe even more important to drive away from situations they do not want to participate in.



Accessories



Foot plate/Heel stops
86121x/861252



Hinged sandals for flip up foot plate
86122x



Formed foot plates
86149, 86147, 86148



Separate foot support
86120x



Knee supports, hinged
86131x



Abdominal support
861411



Hip support, front
86160x



Hip support, derotational
86161x



Hip support, rear
86150x



Surrounding hip support
861610, 861620, 861630



Back support
86401

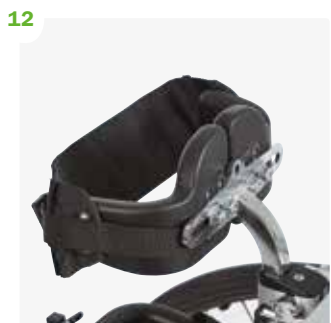

Chest support
86170x

For more accessories - visit our website

13



Chest support
86180x

14



Chest support
8618x0

15



Distance piece
861421, 861422

16



Extension piece
861480

17



Connecting system for head support
861424-3, 861424-4

18



Play box
862501

19



Tray
862515

Gustav, 7 years old
"So you think you can go faster than me..."





User height
1000–2000 mm



Max. load
70 kg



Environment
Indoor only

Toucan[®]

The Toucan standing frame comes with soft curves and smart colours. It is designed to support the user in the upright and prone position.

The Toucan is available in 5 sizes.

Highlights about Toucan



Angle adjustable centre bar

The Toucan has easy and smooth angle adjustment making it possible to obtain the optimum standing position.



The Toucan is designed with slots in the centre bar for mounting accessories

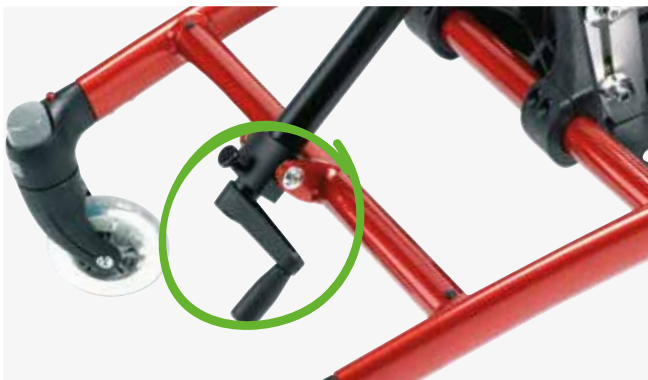

Handle with lock

The handle for angling the centre bar is equipped with a security lock. Pull out the lock whilst turning the handle to change the angle.



Castors with locks

All four wheels are equipped with locks securing the Toucan for stability. The wheels are very easy to manoeuvre making it easy to move the Toucan around.



Standard

Frame, castors, wheel locks, centre bar, tilt wind system.

Options

Five sizes

- Size 1
- Size 2
- Size 3
- Size 4
- Size 5

Frame colour



Red for
size 1



Blue for
size 2+3











Silver for
size 4



As standard the Toucan is delivered with frame and centre bar. Please flip once to find accessories

Measurements

| | | 1 | 2 | 3 | 4 | 5 |
|---|----------------------------|------------|-------------|-------------|--------------|--------------|
|  | User height: floor to axil | 340–700 mm | 540–900 mm | 740–1100 mm | 910–1210 mm | 1110–1410 mm |
|  | Max. load | 30 kg | 40 kg | 50 kg | 60 kg | 70 kg |
|  | Height floor to frame | 60 mm | 60 mm | 60 mm | 60 mm | 60 mm |
|  | Angling | 0–30° | 0–30° | 0–30° | 0–20° | 0–20° |
|  | Length | 750 mm | 880 mm | 880 mm | 1110 mm | 1110 mm |
|  | Overall width | 560 mm | 630 mm | 630 mm | 700 mm | 700 mm |
|  | Overall height | 670–870 mm | 720–1010 mm | 970–1230 mm | 1040–1340 mm | 1240–1540 mm |
|  | Total mass | 7,5 kg | 8,5 kg | 9 kg | 10,5 kg | 10,75 kg |

Further measurements at our website

Nice to know

The distance from the floor to the foot plate is only 60 mm, which makes it possible for most of the target users to step into the Toucan.

The target users will be able to maintain antigravity head posture; however, it is possible to mount a head support to compensate for inability to maintain the head alignment during standing.



Accessories



Foot plate/Heel stops
86121x/86125x



Hinged sandals
86122x



Formed foot plates
86149, 86147, 86148



Separate foot support
86120x



Knee supports
86131x, 86130x



Abdominal support
861411



Hip support, front
86160x



Hip support, derotational
86161x



Hip support, rear
86150x



Surrounding Hip support
8616x0



Back support
861401

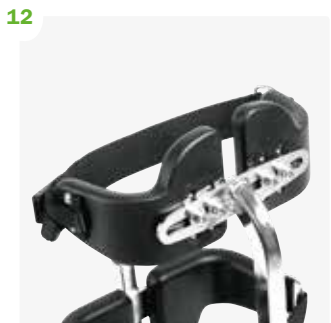

Chest support
86170x

For more accessories - visit our website

13



Chest support
86180x

14



Chest support
8618x0

15



Distance piece
861421, 861422

16



Extension piece
861480

17



Connecting system for head support
861424-3, 861424-4

18



Tray plastic
86112x

19

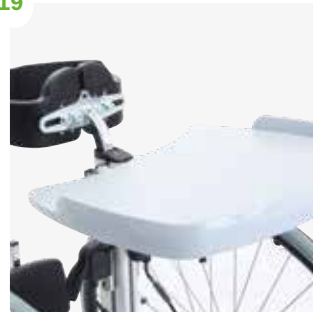

Tray
862515

20



Tray, wood/Arm rests
86110x/ 861111

Bertram, 3 years old

“Am I the only one that loves playing?”





User height
850–1840 mm



Max. load
100 kg



Environment
Indoor only

Caribou®

The Caribou is a standing frame that supports a prone or supine standing position. The Caribou is available in 4 sizes and suitable for children and teenagers.

Highlights about Caribou



Easy transfer

The Caribou tilts from vertical to horizontal. The horizontal position makes it easier for the carer and less stressful for the user to be placed into position.

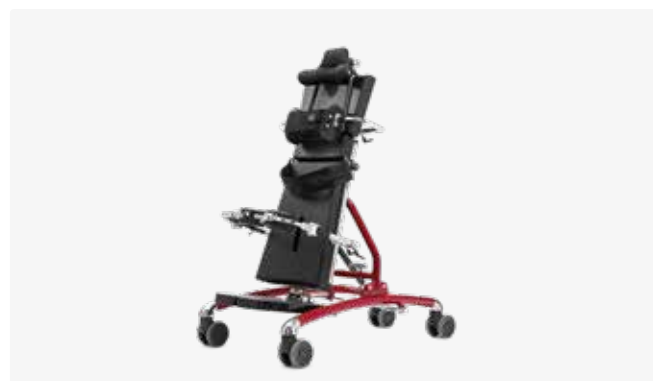

Compatible accessories

The Caribou accessories are compatible with all sizes, and are easily fitted and adjusted on the Caribou frame.

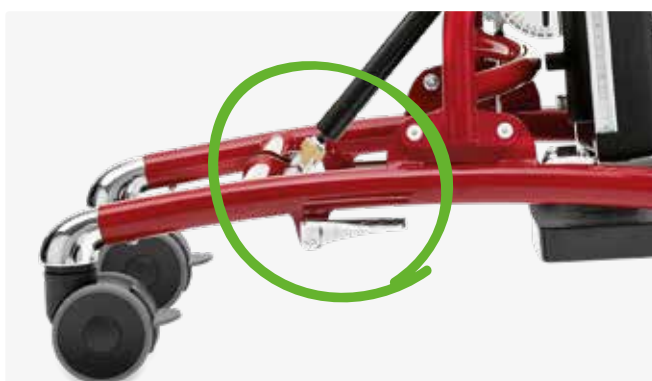

Easy tilt

The Caribou is supplied with an easy tilt mechanism.



Anatomic design and comfortable

Soft mouldable PU for comfort.



Standard

100 mm castors with locks, height and angle adjustable parted foot support, tilt: From vertical to horizontal.

Options

| Size | Version* | Foot plate |
|--|--------------------------|---|
| - Size 1 - Size 2 - Size 3 - Size 4 | - with power - manual | - Parted foot supports makes it possible to adjust individual foot heights and angles |

*Sizes 3 and 4 are recommended in the power versions to ease tilting

Frame colour



Yellow for size 1



Red for size 2



Blue for size 3











Anthracite grey for size 4



The Caribou can be ordered as either manual or power version

Measurements

| | | 1 | 2 | 3 | 4 |
|---|-----------------------|-------------|-------------|--------------|--------------|
|  | User height | 850–1120 mm | 980–1290 mm | 1250–1560 mm | 1530–1840 mm |
|  | Max. load | 40 kg | 60 kg | 80 kg | 100 kg |
|  | Height floor to frame | 130 mm | 130 mm | 130 mm | 130 mm |
|  | Angling | 0–87° | 0–87° | 0–87° | 0–87° |
|  | Length | 750 mm | 920 mm | 1110 mm | 1110 mm |
|  | Overall width | 510 mm | 570 mm | 650 mm | 750 mm |
|  | Overall height* | 790 mm | 910 mm | 1130 mm | 1410 mm |
|  | Total mass | 20,5 kg | 24 kg | 30,5 kg | 35 kg |

Further measurements at our website
*Configuration: Standard product and top plate (measured from the floor)

Nice to know

The extensive accessories selection allows children and youngsters who have severe limitations in head and trunk control or who experience limitations in their range of motion to adopt the standing position. Thereby the Caribou supports the child to participate in things they value – and it can bridge the disparities between children with and without disabilities.

When used for prone standing, the shape of the top plate ensures freedom of movement and allows the child to use their arms and hands actively, for instance at the table in front of the body and standing frame.



Accessories



1
Top plate/Head plate
861101-x/861116-x



2
Cross straps/Chest strap
862102-x/862101-x



3
Side supports
861102-x



4
Straps for side supports
86103-x, 862103-x



5
Shoulder support
861126-x



6
Wedges for side slots
861107-x



7
Head support
9945493-83 / 9967493-83



8
Extra cushions
861106-x



9
Back support
861115-x



10
Upper arm supports
861109-x0,
Side supports
861102-x



11
Pommel
861103-x
Strap for pommel
862104-x

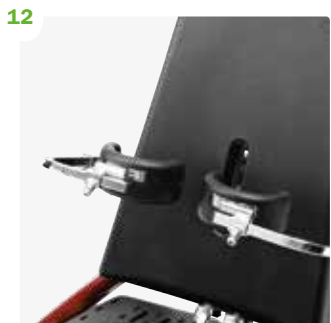

12
**Knee supports, fixed/
Knee supports, hinged, fixed**
861144-x/861144-xx

For more accessories - visit our website

13



Knee supports, swing-away
861154-x

14



Knee supports, hinged, swing-away
861154-xx

15



Formed foot plates
8614x

16



Heel supports
86125x

17



Tray, low mounting
862131-1, 862131-2

18



Tray
862130-x

19



Arm rests for plastic tray
861131

20



Toybar for plastic tray
861135

21



Grip handle for plastic tray
8910750

22



Helper's handle
861108-U

23



Fix locks
862109-35

24



Conversion kit
860113-KIT, 860114-KIT



User height
700–1350 mm



Max. load
80 kg



Environment
Indoor only

Gazelle PS[®]

Gazelle PS stands for Prone and Supine which means it can be used by children who need to be supported on their fronts or backs. It offers up to 30 degrees of hip abduction in each leg.

The Gazelle PS is available in 3 sizes.

Highlights about Gazelle PS



Tilt vertical-horizontal

The Gazelle PS tilts from vertical to 15° past horizontal. This is an excellent position for respiratory therapy and postural drainage.



Compatible accessories

The Gazelle accessories are compatible with all sizes, and are easily fitted and adjusted on the Gazelle frame.



Multi-adjustable foot supports

Ball joints in foot plates allow for positioning and support for almost any ankle/foot placement.



Manual leg abduction

Gazelle moves in an anatomically correct motion to help position the head of the femur into the acetabulum. You can adjust either one or both legs to the optimal angle.



Standard

Multi adjustable foot support, knee support, foldable bracket for back support, removable back support, trunk safety belt, castors with lock, manual leg abduction, tilt from vertical to horizontal, adjustable trunk or chest support.

Options

Size

- Size 1
- Size 2
- Size 3

Frame colour



Yellow for size 1



Green for size 2



Blue for size 3



As standard the Gazelle PS is supplied with chest and foot straps

Measurements

| | | 1 | 2 | 3 |
|--|----------------------------|------------|-------------|-------------|
| | User height: floor to axil | 450–950 mm | 600–1050 mm | 700–1250 mm |
| | Max. load | 40 kg | 60 kg | 80 kg |
| | Angling | 90 – –15° | 90 – –15° | 90 – –15° |
| | Length | 760 mm | 880 mm | 990 mm |
| | Overall width | 480 mm | 580 mm | 650 mm |
| | Overall height | 760 mm | 800 mm | 900 mm |
| | Total mass | 20 kg | 22 kg | 24 kg |

Further measurements at our website

Accessories

1



Head support system
88124-xx

2



Mounting for head support
88130

3



Facial aperture
88117-x

4



Anat. head support
88119-x

5



Side supports
88055-x

6



Side supports, interior
88075-x

7



Side supports, exterior
88065-x

8



Trunk support
88106-x

9



Angling of lower leg
88165-x

10



Strap for side supports
88250-x

11



Tray with bowl
88113-x

12



Tray
88108-x

For more accessories - visit our website



Walking, overview

| | | Mustang | Crocodile | Pony |
|--------------|---------------------------|----------|-----------|----------|
| Target users | Max. load | 80 kg | 80 kg | 50 kg |
| | User height | 700-1300 | 800-1800 | 700-1350 |
| Features | Adjustable (forward lean) | • | | • |
| | Height adjustable seat | • | | • |
| | Chest support | • | | • |
| | Handles | • | • | • |
| | Easy to access | • | • | |
| | Easy to store and carry | • | • | |
| | Foldable frame | • | • | |
| Environment | Indoor | • | • | • |
| | Outdoor | •* | • | |

*When equipped with 4" castors is primarily intended for indoor use. Can be used outdoor as well on level surfaces



Walking

**Robust and light walking
aids increase mobility!**



User height
700-1800 mm



Max. load
80 kg



Environment
Indoor & outdoor

Mustang[®]

Mustang is a highly adaptable walking aid for children and youngsters and it can be configured with anterior or posterior support to meet a wide range of walking needs.

The Mustang is available in 4 sizes.

Highlights about Mustang



Motivating the child to walk

The user is placed at the centre of the Mustang which provides core stability and enables the user to focus energy on walking.



Easy to access

The Mustang has been constructed with accessibility in mind. The U-shaped frame and wrap around support, allows for easy access and transfer.



Natural walking pattern

The Mustang has an easy to adjust central bar for height and angle adjustment. A slight forward leaning position, combined with built-in suspension, stimulates the natural walking pattern.

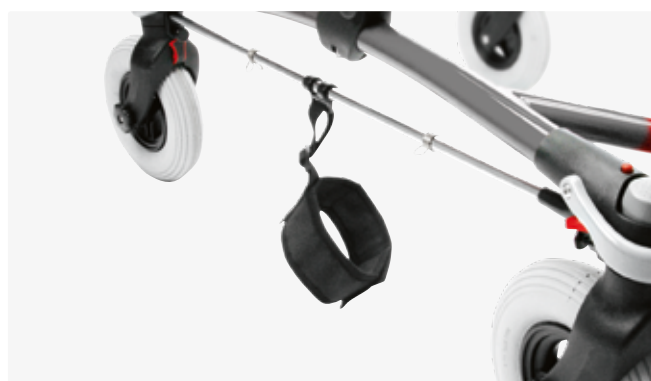

Accessories are easily added or removed for the carers convenience



Standard

Four sizes, directional stabilizer, drag wheel function, tension adjustable wheels, angle adjustment, reverse brake on/off, height adjustment.

Options

Four sizes

- Size 1 yellow
- Size 2 white
- Size 3 red
- Size 4 anthracite grey

Wheels

- 8" solid wheels
- 8" slime line wheels
- 4" wheels for size 1 + 2

Frame colour



Yellow size 1



White size 2



Red size 3



Anthracite
Grey size 4





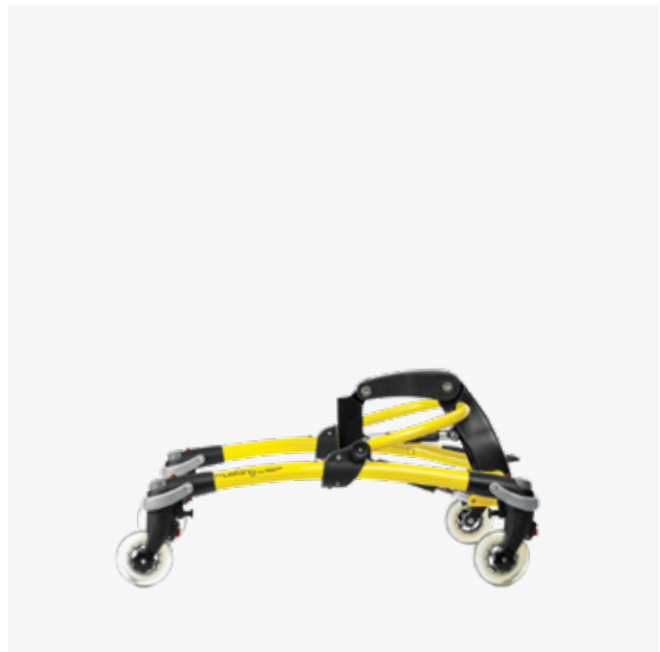



Standard Mustang size 4



Standard Mustang size 1

Measurements

| | | 1 | 2 | 3 | 4 |
|---|-----------------------------|------------|------------|-------------|-------------|
|  | Seat height above floor* | 260–440 mm | 330–500 mm | 450–680 mm | 620–840 mm |
|  | User height: floor to axil* | 400–650 mm | 600–850 mm | 700–1050 mm | 870–1300 mm |
|  | Max. load | 30 kg | 40 kg | 60 kg | 80 kg |
|  | Length* | 820 mm | 900 mm | 1000 mm | 1100 mm |
|  | Overall width | 520 mm | 580 mm | 650 mm | 700 mm |
|  | Turning radius | 460 mm | 550 mm | 600 mm | 650 mm |
|  | Total mass* | 13 kg | 14 kg | 18 kg | 19 kg |

Further measurements at our website

*Measured with 8" wheels. The Mustang is measured as standard delivered and with the center bar in vertical position. Different settings may result in another set of measurements. To accomplish some of the measurements above, a slight adjustment might be required. We supply various types of accessories, which is why the weight is listed without

Nice to know

Mustang is a highly adaptable walking aid, which can be used as a posterior or anterior walker. A recent systematic review was unable to make recommendations for the use of anterior or posterior walkers based on the existing evidence. However, the majority of walking aid user and their parents preferred posterior walkers (Poole 2017).

For children who are "new" walkers the anterior support makes them feel safe and keep them away from hitting objects with the body as they practice their walking skills. The more "experienced" walkers might feel free and more independent and able to get closer to objects with posterior support.



Accessories

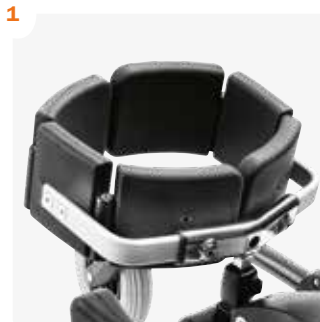

Chest support
8698x0



Cover
8698x0-x60

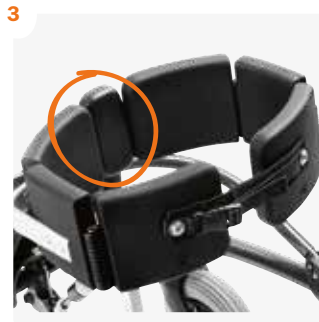

Extension piece
869225

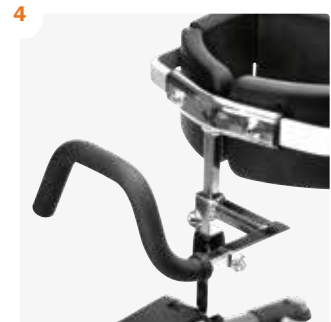

Hand bar
86936x



Abdominal support
869260

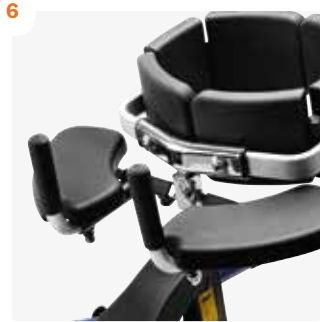

Arm rests, anterior
86935x

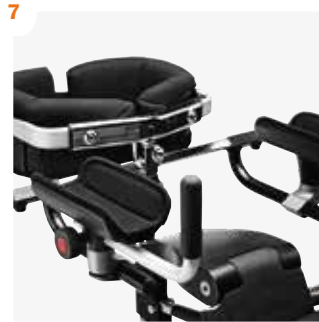

Arm prompts
8693xx



Forearm positioner
869370

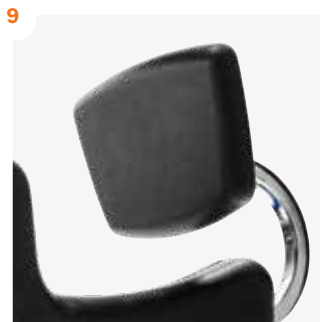

Sacrum support
86925x



Hip support
8692xx



Hip supports on curved bar
869222 or 869232

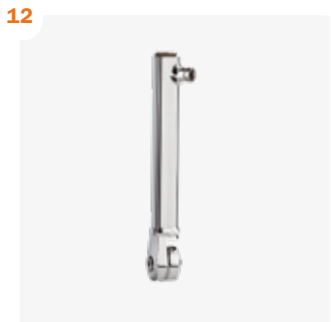

Connecting rod
869226

For more accessories - visit our website

13



Seat
8691x0

14



Sling seat
86957x

15



Leg pad
869470

16

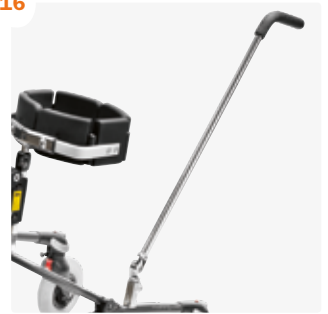

Guide bar
869510

17



Storage pouch
869560

18



Storage bag
869565

19



Leg separator
8694x0

20

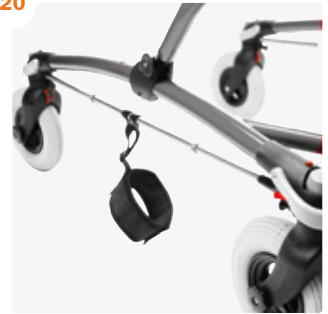

Ankle prompts
8694xx

Bertram, 2 years old

"I run fast - see if you can catch me?"





User height
800–1800 mm



Max. load
80 kg



Environment
Indoor & outdoor

Crocodile®

The Crocodile is a walking aid for children and young adults to help them into a more upright position. It is placed behind the child and its lightweight design makes it easy to move.

The Crocodile is available in 3 sizes.

Highlights about Crocodile



Height adjustable top frame

Easy to adjust the height without using any tools.

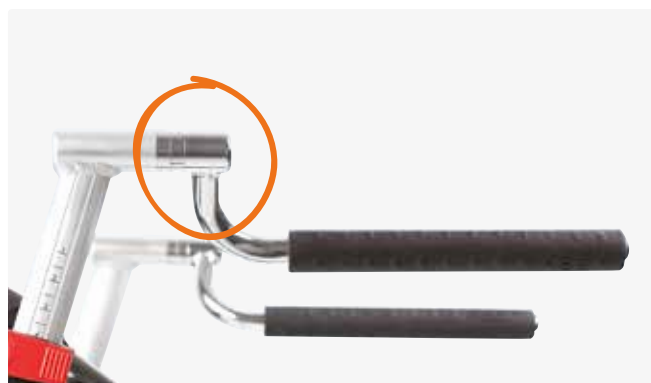

Multi-adjustable handles

Positioning the grips close to the body gives better support and a better walking position.



On/off anti-reverse stops

The anti-reverse wheel stops are used for children with less balance and control.



Foldable frame

Makes storage and transporting the Crocodile easy.



Standard

Width and height adjustable handles, lightweight durable aluminium frame - sizes 1 and 2, stable steel and aluminium frame - size 3, upholstery and cover for top frame, solid front and rear wheels, swivel front wheels with directional stabilizer, adjustable drag wheels (rear wheels), on/off anti-reverse wheel stop.

Options

Three sizes

- Size 1
- Size 2
- Size 3

Frame colour



Yellow,
Size 1



Orange,
Size 2



Metallic
black,
Size 2



Anthracite
grey,
Size 3













Crocodile size 1



Crocodile size 3

Measurements

| | | 1 | 2 | 3 |
|--|-------------------------------|------------|------------|------------|
|  | User height: floor to handles | 420–560 mm | 550–690 mm | 690–870 mm |
|  | User height, maximum | 1150 mm | 1500 mm | 1800 mm |
|  | Max. load | 30 kg | 45 kg | 80 kg |
|  | Length | 720 mm | 840 mm | 870 mm |
|  | Overall width | 620 mm | 690 mm | 690 mm |
|  | Folded length | 720 mm | 860 mm | 1000 mm |
|  | Folded width | 620 mm | 690 mm | 690 mm |
|  | Folded height | 310 mm | 270 mm | 290 mm |
|  | Turning radius | 1000 mm | 1140 mm | 1140 mm |
|  | Total mass | 5,5 kg | 6,5 kg | 12 kg |

Further measurements at our website

Nice to know

The Crocodile is our hand-held walking aid, allowing children with moderate impairments in standing and walking the possibility to be mobile. The accessories can be used to provide the exact support that is necessary for the user to feel safe and independent.



Accessories

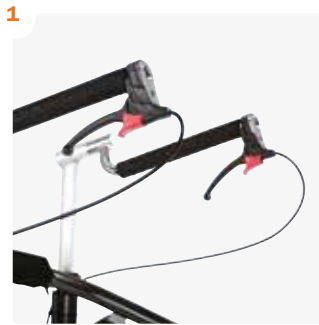

Hand brakes
86834/86873

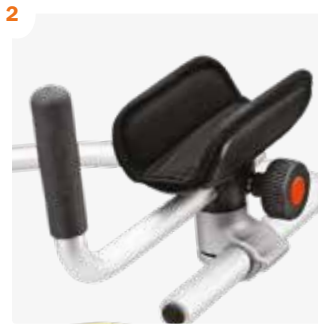

Forearm support
86858/59/60



Forearm positioner
869370

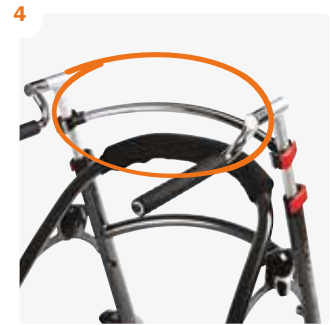

Cross bar
86880



Back and side support
8680x

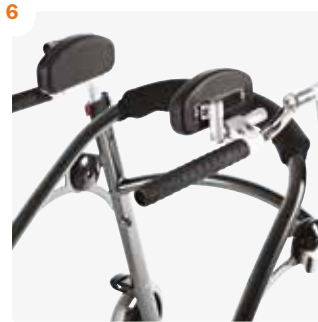

Hip supports
86819



Strap for side supports
Sn4016

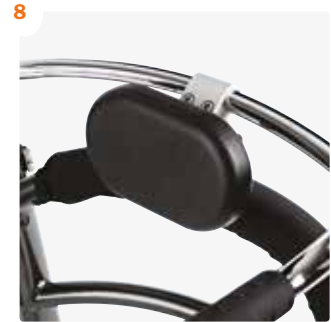

Back support
86816

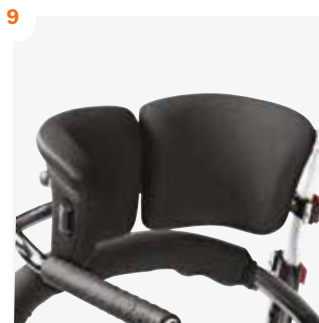

Back support, adjustable
86886

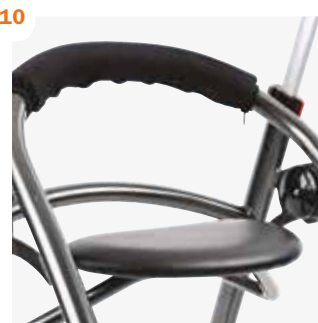

Flip down seat
8682x, 86863



Sling seat
8682x



Handle knobs
86861

For more accessories - visit our website

13



Bag
86839

14



Bag
Size 3, 86843

15

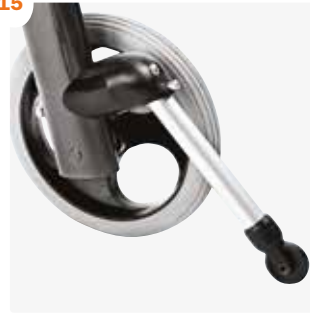

Anti-tips, swing-away
86815 (1-2), 86815-3S (3)

16



Attendants handle
86866

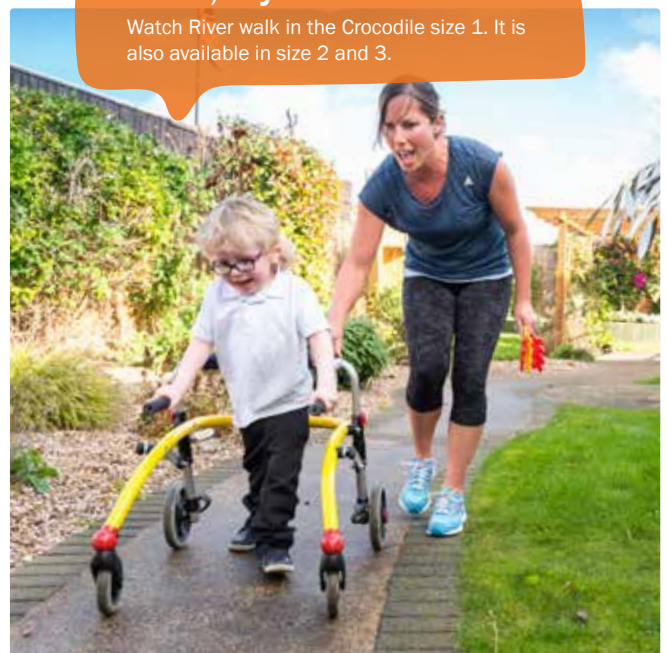

River, 4 years old
Watch River walk in the Crocodile size 1. It is also available in size 2 and 3.



User height
700–1350 mm



Max. load
50 kg



Environment
Indoor only

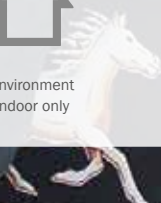

Pony[®]

The Pony is a gait trainer for children with disabilities. It has a frame shaped like an arrow and a central bar that holds the chest support and the seat. The Pony is available in 3 sizes.

Highlights about Pony



Back support

Allows for height and depth adjustment for positioning the pelvis into a neutral position. Furthermore the back support can be removed for easy access into the walker.



Adjustable forward lean

Adjusts to accommodate optimal walking angle and initiate the stepping process.



Height adjustable seat

Allows for height adjustment to fit the user and provide optimum positioning when walking. The child is not supposed to sit on the saddle.



Brakes on castors

The Pony has brakes on the two front castors. Further, it is equipped with one drag wheel and directional stabilizer for added support.



Standard

3 sizes, 5 wheels (1 rear and 2 front with lock), bumper wheels, black center plate, hand bar, seat and back support, safety strap.

Options

Three sizes

- Size 0 yellow
- Size 1 Purple
- Size 2 Lilac

Frame colour



Yellow



Purple



Lilac



Standard Pony, purple



Standard Pony, yellow

Measurements

| | | 0 | 1 | 2 |
|--|-------------------------|------------|------------|-------------|
| | Seat height above floor | 240–380 mm | 380–500 mm | 480–640 mm |
| | Max. load | 30 kg | 40 kg | 50 kg |
| | Length | 670 mm | 720 mm | 1040 mm |
| | Overall width | 590 mm | 690 mm | 770 mm |
| | Overall height | 520–690 mm | 600–820 mm | 680–1040 mm |
| | Total mass | 7 kg | 10 kg | 13,5 kg |

Further measurements at our website

Casper, 4 years old
 "It's so much fun to move freely wherever I want"





Accessories

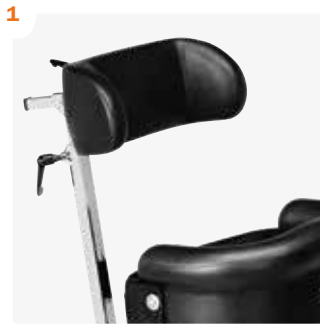

Head support system
86424-xx

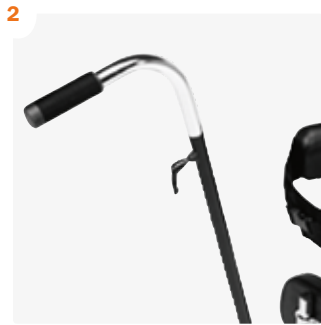

Helper's handle
86416



Arm rest
8642x



Vertical handles
86432



Sacrum support
8642x

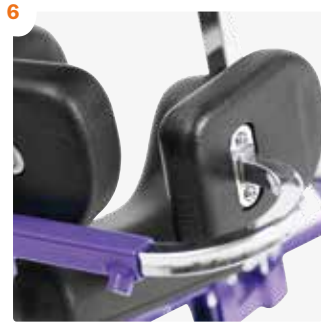

Lateral hip supports
864xx

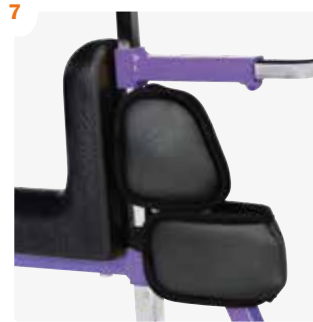

Leg protection
86450



Directional stabilizer
8644x

[For more accessories - visit our website](#)

Nice to know

The Pony gait trainer is popular in settings, where multiple users, reuse, finically viable and less complex walking solutions are warranted.

The simple and solid design of the Pony assist children, who are unable to maintain a standing position and walk, to be mobile indoor over shorter distances.





Transportation, overview

| | | Stingray Swing-out |
|--------------|----------------------------------|--------------------|
| Target users | Max load | 9 / 36 kg |
| | User height | 740-1350 mm |
| Features | Tilt in space | • |
| | Turnable and swing-out | • |
| | Lateral support (chest and hips) | • |
| | Easy-fit system | • |
| Environment | In car | • |
| | Overall width | 420 mm |



Transportation

**Safe and comfortable solutions for the
transport of children with special needs!**



User height
740-1350 mm



Max load
36 kg

Stingray Swing-out® (STS0)

The Stingray Swing-out offers optimum support and function – it tilts, it swivels and it slides. It is available in 4 sizes and suitable for children weighing from 9 to 36 kgs. With its adjustment for growth, it will meet the needs of a growing child for longer.

Highlights about Stingray Swing-out



Swing-out function

The Swing-out frame enables parents to turn and slide the seat in and out of the car so they don't have to bend when lifting the child into the seat. It also avoids straining their back.



EasyFit System

The Stingray swing-out car seat frame is easy to fit in cars with ISOFIX but can also be secured using the Easyfit belt tensing system. The car seat is available in a left or right version.



Tilt Adjustment

The ingenious tilt has a range of 10-30 degrees making it possible to position the child in an active or more relaxed position.



Tested and approved to ECE 4404

The Stingray Swing-out car seat is approved according to ECE 4404 and has been crash tested for user weights between 9 and 36 kgs.



Standard

Adjustable tilt in space 10° to 30°, slide and swing-out function on frame, height adjustable 3-point belt guide for the seat belt, height adjustable headrest, adjustable seat depth, easyfit mounting system for Isofix brackets.

Options

4 sizes

- Maat 1
- Maat 2
- Maat 3
- Maat 4

Fastening in car

- Easyfit system
- Evo tension belt

Cushion colours



Blue



Red



Green



Pink



Grey



Yellow



Orange

Frame colour



Black



Standard Stingray Swing-out

Measurements

| | | 1 | 2 | 3 | 4 |
|--|----------------------|------------|------------|------------|------------|
| | Effective seat width | 200–280 mm | 200–280 mm | 260–380 mm | 260–380 mm |
| | Effective seat depth | 170–240 mm | 210–280 mm | 270–340 mm | 290–360 mm |
| | Backrest height | 350–450 mm | 380–480 mm | 430–530 mm | 480–580 mm |
| | Min. load | 9 kg | 9 kg | 9 kg | 9 kg |
| | Max load | 36 kg | 36 kg | 36 kg | 36 kg |
| | Seat plane angle | 10–30° | 10–30° | 10–30° | 10–30° |
| | Overall width | 42 cm | 42 cm | 42 cm | 42 cm |
| | Total mass | 21 kg | 22 kg | 23 kg | 24 kg |

Further measurements at our website

Accessories

1

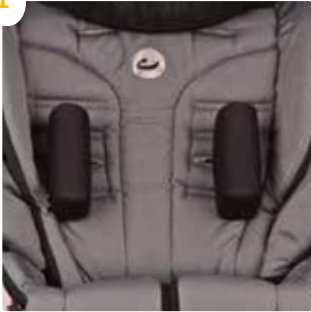

Side supports
NLPE040/041

2



Hip supports
87402x0 (adjustable and non-adjustable)

3



5-point belt
ECE Belt
NLPE010, 89655-x, 89655-xUK

4



Outer knee supports
NLPE043/044

5



Foot support
8775010 and NLPE046

6



Height adjustable headrest

7

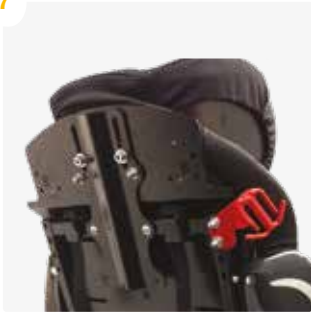

Height adjustable belt guide for proper positioning of the seat belt



Toilet and bath, overview

| | | Flamingo high-low | Flamingo | Heron |
|--------------|-------------------------------|-------------------|-------------|--------------|
| Target users | Max. load | 70 kg | 70 kg | 130 kg |
| | User height | 900-1700 mm | 900-1700 mm | 1400-1800 mm |
| Features | Seat plane angle | • | • | • |
| | Back recline | • | • | • |
| | Height adjustable frame | • | • | • |
| | Foldable frame | • | • | |
| | Depth adjustable seat | | | • |
| Environment | Indoor (bathroom environment) | • | • | • |

| | | Swan | Manatee | Orca | Penguin |
|--------------|-------------------------------|--------------|-------------|-------------|------------|
| Target users | Max. load | 110 kg | 75 kg | 120 kg* | 20 kg |
| | User height | 1000-1800 mm | 700-1300 mm | 600-1200 mm | 620-900 mm |
| Features | Seat plane angle | • | | | |
| | Back recline | | | | |
| | Height adjustable frame | • | • | • | |
| | Foldable frame | | • | | |
| | Depth adjustable seat | | • | | • |
| Environment | Indoor (bathroom environment) | • | • | • | • |

*Max. user weight: 50 kg



Toilet & bath

Mobile toilet seats and bath seats provide carers with the best possible working conditions!



User height
900–1700 mm



Max. load
70 kg



Environment
Indoor only

Flamingo High-low[®]

Flamingo High-low is a modern height adjustable toilet and shower seat, allowing carers to perform bathing tasks in a convenient and good working position. The Flamingo High-low is available in 4 sizes.

Highlights about Flamingo High-low



Adaptation of working conditions

Height adjustability eases transition between shower, toilet and sink and provides optimum working conditions for the carer.



Optimum positioning

The Flamingo High-low offers simple tilt-in-space and back recline functions. It is very easy to position the user with knees higher than the hips which has been proven very effective for bowel function.



Easy to use

The Flamingo High-low has easily accessible foot pedals for height adjustment and tilt-in-space. The pedals are equipped with security locks for added safety.



Inlay seat with wider sides for comfort and reduced seat width



Standard

Height adjustable frame, 4 white castors with lock, tilt in space, foot support, recline, stainless steel frame, active back (no sides), 100 % waterproof upholstery for seat and back, splash guard - high model.

Options

Size

- Size 1
- Size 2
- Size 3
- Size 4

Colours



Grey



Blue

Frame colour



White











Flamingo High-low size 1 and 2









Flamingo High-low size 3 and 4

Measurements

| Seat | | 1 | 2 | 3 | 4 |
|---|----------------------|--------|--------|--------|--------|
|  | Effective seat width | 240 mm | 280 mm | 320 mm | 340 mm |
|  | Effective seat depth | 250 mm | 290 mm | 350 mm | 400 mm |
|  | Backrest height | 350 mm | 380 mm | 420 mm | 470 mm |
|  | Max. load | 35 kg | 50 kg | 60 kg | 70 kg |
|  | Backrest angle | 30° | 30° | 30° | 30° |
|  | Length | 260 mm | 315 mm | 360 mm | 425 mm |
|  | Overall width | 350 mm | 380 mm | 430 mm | 480 mm |
|  | Overall height | 400 mm | 430 mm | 480 mm | 510 mm |
|  | Total mass | 2,5 kg | 3 kg | 4 kg | 4,5 kg |

Further measurements at our website

| Frame and Seat | | 1 | 2 | 3 | 4 |
|---|-----------------------------------|-------------|-------------|-------------|--------------|
|  | Seat surface height at front edge | 530–740 mm | 530–740 mm | 530–740 mm | 530–740 mm |
|  | Max. load | 35 kg | 50 kg | 60 kg | 70 kg |
|  | Seat plane angle | -5°–20° | -5°–20° | -5°–20° | -5°–20° |
|  | Length | 640 mm | 640 mm | 760 mm | 760 mm |
|  | Overall width | 500 mm | 500 mm | 570 mm | 570 mm |
|  | Overall height | 860–1080 mm | 920–1110 mm | 940–1170 mm | 1020–1200 mm |
|  | Total mass | 14 kg | 14,5 kg | 16,5 kg | 17 kg |

Further measurements at our website



Accessories



1
Head support
990x148-00



2
Push brace
880110



3
Sides w/upholstery
88011x

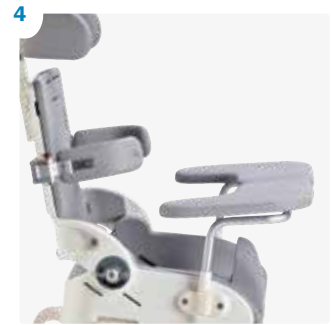

4
Side supports/Tray
83xxx-xx/88013x



5
Side Supports
88401-x0

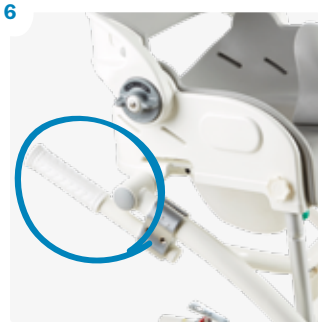

6
Push handle
880110-HL



7
Armrests
880152



8
Commode pan
112401, 880129
Lid for commode pan
8801xx-L



9
Upholstery with wide sides
88016x



10
Hardware for toilet mounting
88014x



11
Vest & belts
89xxx-x40



12
Neoprene hip belt
85423-x

For more accessories - visit our website

13



Calf Support
880199

14



Splash guard, low
880195, 880196

15



Potty frame
880160-x

16



Seat infill
88018x

17



Suction cups
880150

18



Wheels (100mm)
880100-S

19



Back reinforcement kit
880155

20



Back/Rod extension
880118+880119/880120

21



Wheels (100 mm)
880100-S



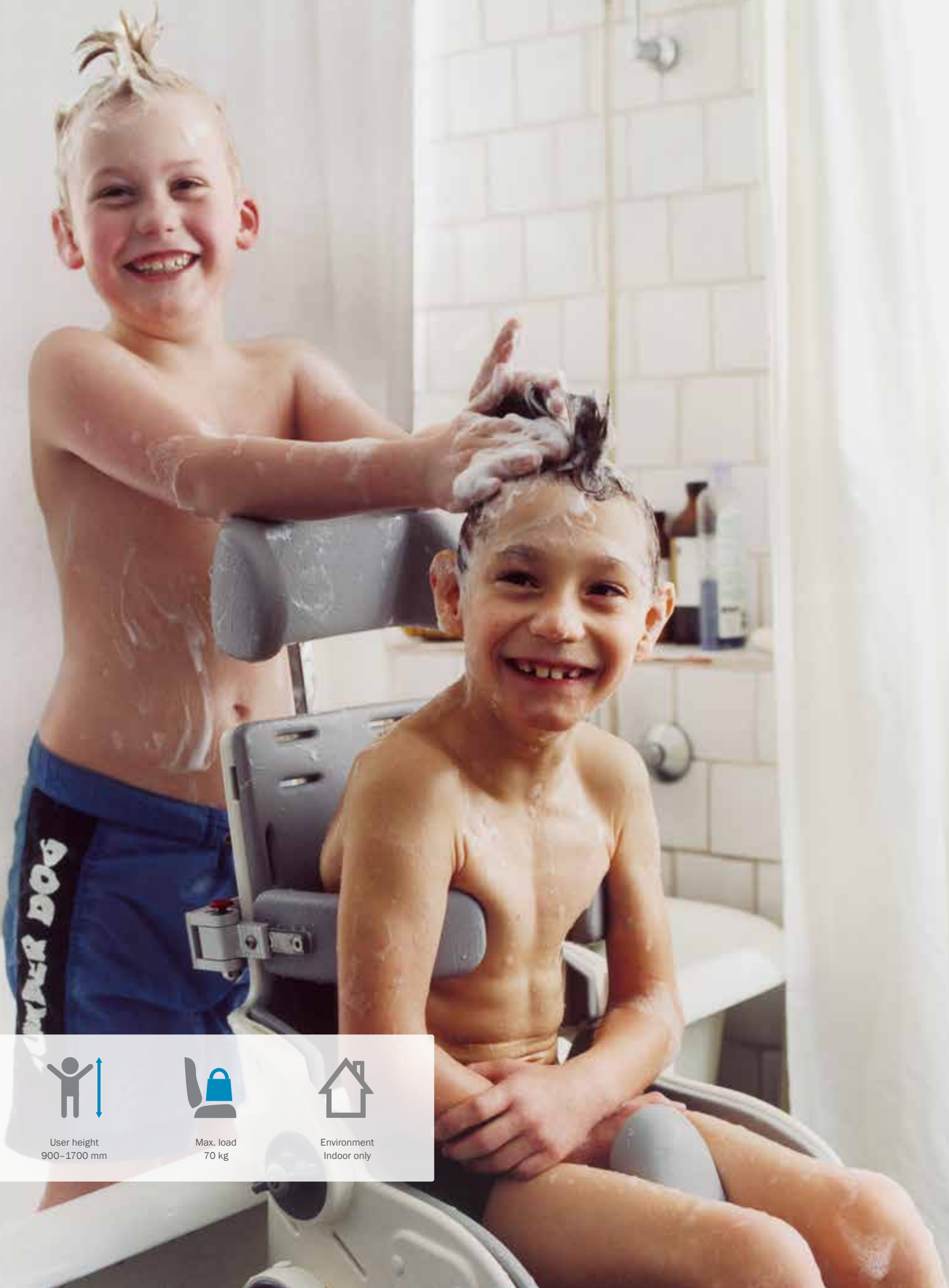

User height
900–1700 mm



Max. load
70 kg



Environment
Indoor only

Flamingo[®]

The Flamingo is a toilet/bathing chair. It is adjustable in height and can be placed over the toilet or be used with a pan.

The Flamingo is available in 4 sizes.

Highlights about Flamingo



Tilt in space and back recline

Tilts and reclines for the child's comfort and positioning.



Accessories can easily be added



Height adjustable frame

Adjusts to fit the height of the carer.



Adjustable foot supports

Adjust to ensure correct positioning and support.



Standard

Height adjustable and foldable frame, 4 white castors with lock, tilt in space, foot support, recline, aluminium frame, active back (no sides), 100 % waterproof upholstery for seat and back, splash guard - high model.

Options

- Size**
- Size 1
 - Size 2
 - Size 3
 - Size 4

Colours

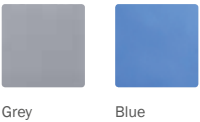

Grey

Blue

Frame colour



White











Standard Flamingo, grey













Standard Flamingo, blue

Measurements

| Seat | | 1 | 2 | 3 | 4 |
|---|----------------------|--------|--------|--------|--------|
|  | Effective seat width | 240 mm | 280 mm | 320 mm | 340 mm |
|  | Effective seat depth | 250 mm | 290 mm | 350 mm | 400 mm |
|  | Backrest height | 350 mm | 380 mm | 420 mm | 470 mm |
|  | Max. load | 35 kg | 50 kg | 60 kg | 70 kg |
|  | Backrest angle | 30° | 30° | 30° | 30° |
|  | Length | 260 mm | 315 mm | 360 mm | 425 mm |
|  | Overall width | 350 mm | 380 mm | 430 mm | 480 mm |
|  | Overall height | 400 mm | 430 mm | 480 mm | 510 mm |
|  | Total mass | 2,5 kg | 3 kg | 4 kg | 4,5 kg |

Further measurements at our website

| Frame and Seat | | 1 | 2 | 3 | 4 |
|---|-----------------------------------|------------|------------|------------|------------|
|  | Seat surface height at front edge | 500–600 mm | 500–600 mm | 500–600 mm | 500–600 mm |
|  | Max. Load | 35 kg | 50 kg | 60 kg | 70 kg |
|  | Seat plane angle | -15°–35° | -15°–35° | -15°–35° | -15°–35° |
|  | Length | 660 mm | 660 mm | 660 mm | 660 mm |
|  | Overall width | 440 mm | 460 mm | 500 mm | 540 mm |
|  | Overall height | 860 mm | 890 mm | 930 mm | 950 mm |
|  | Folded length | 740 mm | 740 mm | 740 mm | 740 mm |
|  | Folded width | 440 mm | 460 mm | 500 mm | 540 mm |
|  | Folded height | 200 mm | 200 mm | 200 mm | 200 mm |
|  | Total mass | 11 kg | 13 kg | 14 kg | 15 kg |

Further measurements at our website



Accessories



Head support
990x148-00



Push brace
880110



Sides w/upholstery
88011x

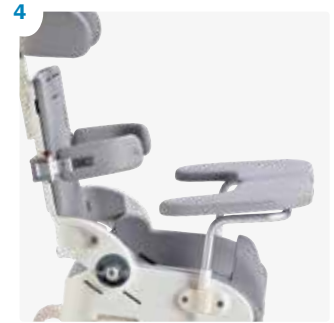

Side supports/Tray
83xxx-xxx/88013x



Armrests
880152



Side Supports
88401-x0



Commode pan
112401, 880129
Lid for commode pan
8801xx-L



Potty ring
88012x-PR



Hardware for toilet mounting
88014x



Upholstery with wide sides
88016x



Vest & belts
89xxx-x40



Neoprene hip belt
85423-x

For more accessories - visit our website

13



Calf support
880199

14



Potty frame
880160-x

15



Seat infill
88018x

16



Splash guard, low
880195, 880196

17



Suction cups
880150

18



Wheels (100 mm)
880100-S

19



Back/Rod extension
880118+880119/880120

20



Back reinforcement kit
880155

Lucas, 6 years old

"It's fun to get my hair washed by a friend"

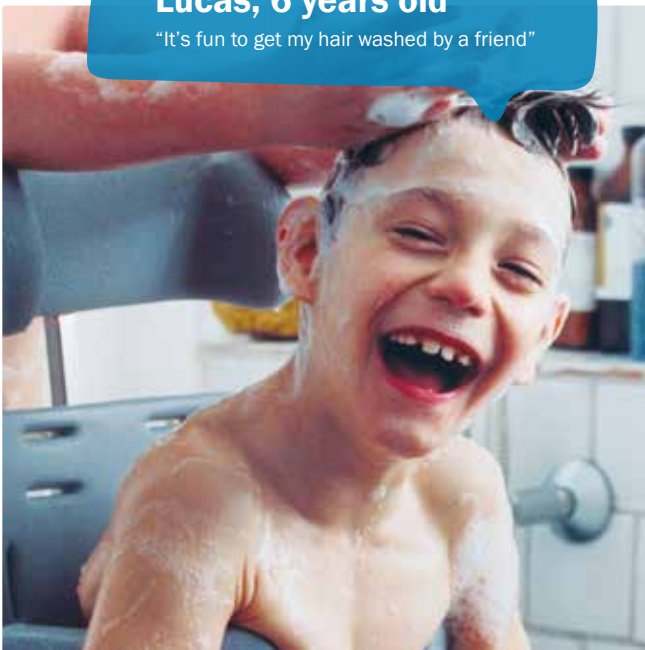



User height
1400-1800 mm



Max. load
130 kg



Environment
Indoor only

Heron[®]

The Heron is a state of the art toilet and bathing seat. It is available with and without power. The simple design and clean appearance conceal multiple functionality features that improve both the user and carer experience.

Highlights about Heron



Optimum positioning

The Heron is suitable for teenagers and transition to young adults. Change the back height and add a couple of simple accessories to change seat width and seat depth – it is easy to make the Heron fit perfectly!



Perfect working conditions

One of the great features of the Heron is the hydraulic or powered height adjustment which allows you to adjust the chair into the correct position.

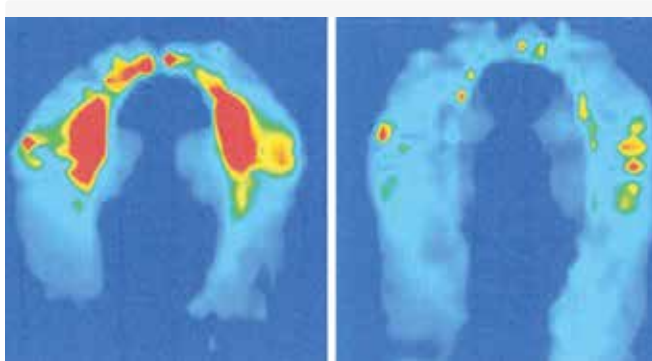

Pressure mapping has been used in the design of Heron to minimise pressure



Heron is available as a hydraulic (100kg) or power version (130kg)



Standard

4 grey castors with locks, stainless steel frame, height adjustable frame, integrated push handles, built-in tilt in space, built-in recline, active - height adjustable back, potty ring.

Options

- Version**
- Hydraulics
 - Power

Colours



Grey

Frame colour



White













Heron with hydraulic whitout upholstery (standard)



Heron with power and various accessories

Measurements

| | | Hydraulics | Power |
|---|-----------------------------------|--------------|--------------|
|  | Effective seat width | 550 mm | 550 mm |
|  | Effective seat depth | 450 mm | 450 mm |
|  | Backrest height | 550-620 mm | 550-620 mm |
|  | Seat surface height at front edge | 510-780 mm | 560-780 mm |
|  | Max. load | 100 kg | 130 kg |
|  | Backrest angle | 90°-120° | 90°-120° |
|  | Seat plane angle | -5°-25° | -5°-25° |
|  | Length | 710 mm | 710 mm |
|  | Overall width | 670 mm | 670 mm |
|  | Overall height | 1080-1350 mm | 1130-1350 mm |
|  | Total mass | 28 kg | 31 kg |

Further measurements at our website

Nice to know

The 125 mm grey castors with locks make it easy to manoeuvre the chair and minimises the demand of the caregiver.

Heron is washable at 85 °C in a washing machine designed for medical devices. Remember to remove all accessories, unplug all cables and make sure to dismantle the control box, battery and remote control before machine washing.



Accessories



Head support
990xxx-00



Upholstery/Shoulder supports
880507-04/880508-01



Side supports, swing-away
83xxx-xxx



Arm rests/Tray
880508-03/880508-04



Hip supports
880508-09



Commode pan
880130
Lid for commode pan
880130-L



Upholstery
101204, back/117005, seat



Splash guard
880508-05



Splash guard, low
880508-07

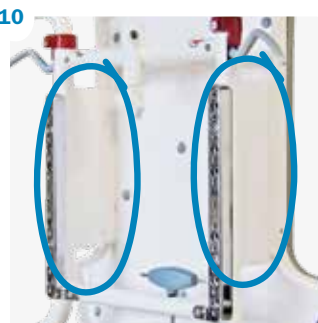

Seat depth reduction kit
880508-06



Vests & belts
89xxx-x40



Foot supports, short/long
880506-03/880506-01

For more accessories - visit our website

13



Foot supports, open
880506-02

14



Padding for foot supports
880506-12

15



Calf support
880509-01

16



Heel stops
880509-02

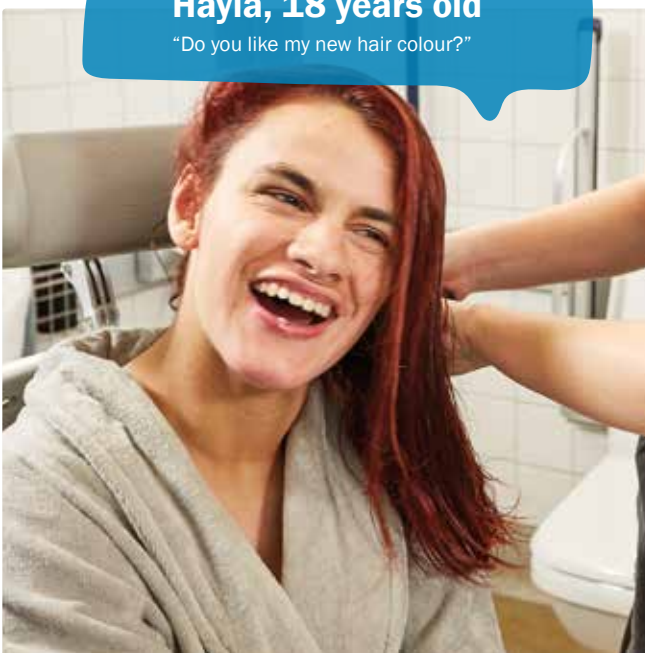

Hayla, 18 years old
"Do you like my new hair colour?"





User height
1000-1800 mm



Max. load
110 kg



Environment
Indoor only

Swan[®]

Swan is a simple toilet and bathing chair. The seat is made of a smooth material, which makes it easy to clean. The frame and castors are stainless steel with rust-proofed surfaces.

The Swan is available in 6 sizes.

Highlights about Swan



Tilt in space

Tilts 20° for the child's optimum positioning and comfort.



Anatomical shape

The Swan has a carefully designed shape that follows the user's contours for improved stability and comfort.



Holder for pan

For use of pan inside or outside the bathroom.



The stainless steel legs adjust to accommodate most toilets



Standard

For size 2 - 3: 4 height adjustable legs, holder for commode pan, tilt in space, built-in pommel.

For size 4 - 7: 4 height adjustable legs, holder for commode pan, tilt in space, 4 white castors with lock, removable splash guard.

Options

Six sizes

- Size 2
- Size 3
- Size 4
- Size 5
- Size 6
- Size 7

Frame and seat colour











White



Swaan is available in 6 sizes and two versions. Sizes 2 - 3 include a built-in pommel. Sizes 4 - 7 include a removable splash guard.

Measurements

| | | 2 | 3 | 4 | 5 | 6 | 7 |
|---|----------------------|------------|------------|------------|------------|-------------|-------------|
|  | Effective seat width | 200 mm | 230 mm | 250 mm | 300 mm | 340 mm | 410 mm |
|  | Effective seat depth | 270 mm | 325 mm | 325 mm | 380 mm | 460 mm | 460 mm |
|  | Backrest height | 380 mm | 420 mm | 400 mm | 480 mm | 570 mm | 570 mm |
|  | Max. load | 30 kg | 60 kg | 70 kg | 80 kg | 90 kg | 110 kg |
|  | Seat plane angle | 18° | 18° | 27° | 22° | 20° | 20° |
|  | Length* | 460 mm | 570 mm | 570 mm | 570 mm | 620 mm | 620 mm |
|  | Overall width* | 490 mm | 535 mm | 535 mm | 535 mm | 575 mm | 655 mm |
|  | Overall height* | 680-840 mm | 790-950 mm | 710-870 mm | 780-940 mm | 860-1020 mm | 860-1020 mm |
|  | Total mass | 8 kg | 9,5 kg | 8,5 kg | 9,5 kg | 10,5 kg | 11,5 kg |

Further measurements at our website
*Measured with wheels

Nice to know

The simple and easy to clean design makes the swan popular in settings, where multiple users, reuse, finically viable and less complex solutions are warranted. Add the padded upholstery and a head support to increase the comfort of the user.

The swan allows caregivers of children with difficulties in maintaining the sitting position while toileting and showering the possibility to assist them with basic self-care.



Accessories



Head support
990xxx-00



Push brace
880110



Padded upholstery
8711x



Mesh vest/Cross vest
89xxx-x40



Tray
8703x



Commode pan
8801xx
Lid for commode pan
8801xx-L



Splash guard
880508-05



Castors
87100-20



Rod for foot support
8702x



Footplate
87145-x

For more accessories - visit our website

Cristal, 3 years old

"I can't wait to try this chair in the shower"





User height
850-1700 mm



Max. load
75 kg



Environment
Indoor only

Manatee®

The Manatee bathing chair is designed to place the user in exactly the right sitting position. The depth of the seat can be adjusted, allowing the bathing chair to “grow” with the child.

The Manatee is available in 4 sizes.

Highlights about Manatee



Head cushion/lateral support

Provides support and comfort for bathing children. Cushions can be used for head or torso support.



Adjustable back and leg rests

Allows adjustments of the back and lower leg supports with a simple pull of a strap or push of a button.



Provides depth adjustment for growth



Adjustable waist strap

Supports the child safely in the Manatee.



Standard

Head/lateral support, belt for waist/hip.

Options

Four sizes

- Size 0
- Size 1
- Size 2
- Size 3

Colours



Blue



Red

Frame colour



Silver



















Standard Manatee with Head/lateral support and belt for waist/hip



The Manatee can be lowered to within 14 cm of the bottom of the bath. It is lightweight and it folds flat for storage. The seat can also be placed directly into an ordinary bath tub

Measurements

| Seat | | 0 | 1 | 2 | 3 |
|---|----------------------|--------------|--------------|--------------|--------------|
|  | Effective seat width | 330 mm | 330 mm | 330 mm | 400 mm |
|  | Effective seat depth | 220-250 mm | 300-370 mm | 390-460 mm | 400-470 mm |
|  | Backrest height | 430 mm | 430 mm | 580 mm | 640 mm |
|  | Max. load | 50 kg | 50 kg | 60 kg | 75 kg |
|  | Overall width | 420 mm | 420 mm | 420 mm | 490 mm |
|  | Folded length | 1030-1100 mm | 1100-1170 mm | 1360-1430 mm | 1440-1510 mm |
|  | Folded width | 420 mm | 420 mm | 420 mm | 490 mm |
|  | Folded height | 130 mm | 130 mm | 130 mm | 130 mm |
|  | Total mass | 5,5 kg | 5,5 kg | 6 kg | 7 kg |

| Frames | Shower frame | Bath tub frame | |
|---|-----------------|----------------|-------------|
|  | Max. Load | 75 kg | |
|  | Length | 980 mm | 990-1110 mm |
|  | Overall width | 590 mm | 435 mm |
|  | Overall height* | 760-900 mm | 270 mm |
|  | Folded length | 980 mm | - |
|  | Folded width | 590 mm | - |
|  | Folded height | 210 mm | - |
|  | Total mass | 8 kg | 2 kg |

*Height measured with chair
Further measurements at our website



Accessories



Torso strap
88302x, 88307x



Pommel
88304x, 88309x



Leg supports
88305x, 88310x



Pads for head/Lateral support
88301x, 88306x



Bath tub frame - basic version
882101



Net
88210x



Shower frame - height adjustable
882100



Wall mounting
882110



For more accessories - visit our website

Casper, 4 years old

'I look forward to a good long bath'





User height
600-1200 mm



Max. load
120/20 kg



Environment
Indoor only

Orca | Penguin[®]

The Penguin can be used in the Orca bath tub, but fits ordinary bath tubs as well. With its suction cups, the Penguin sits firmly on most smooth surfaces. Orca and Penguin are available in one size.

Highlights about Orca | Penguin



Excellent working conditions

Free space around the sides makes it easier for a carer to get close to the child providing optimum comfort. Four smooth running wheels makes it easy to move the bath tub around.



Easy to handle

The frame can be taken apart to minimise space for storage or transportation. The smooth and hygienic surface makes it very easy to clean.



Penguin - suction cups

Secures the Penguin in the bath tub.



Freedom of movement



Standard, Orca

One size, height adjustable frame, soap tray, plug, drain pipe.

Standard, Penguin

One size, suction cups.

Frame and seat colour



White



Standard Orca



Standard Penguin

Measurements

Orca

| | | |
|---|---------------------------------|-------------|
|  | Bath tub width, inside, bottom | 400 mm |
|  | Bath tub length, inside, bottom | 860 mm |
|  | Max. load | 120 kg* |
|  | Length | 1110 mm |
|  | Overall width | 550 mm |
|  | Overall height | 940-1150 mm |
|  | Total mass | 16 kg |

*Max user weight: 50 kg

Penguin

| | | |
|---|------------------------------|------------|
|  | Inside width, tightest place | 160 mm |
|  | Inside length | 560-720 mm |
|  | Max. load | 20 kg |
|  | Length | 800 mm |
|  | Overall width | 330 mm |
|  | Overall height | 260 mm |
|  | Total mass | 1.35 kg |

Nice to know

Orca makes it possible for caregivers using a seated position, such as a wheelchair user, the opportunity to participate and be at eye level in the bathing situation.

The Orca comes with a plug drain and drain pipe for quicker and easier emptying.

Accessories



Orca



Extension hose
111555



Orca + Penguin seat



Orca + Flamingo seat



Penguin



Soap dish



Plug

Philippa, 2 years old

"I love a long and relaxing bubble bath"







Accessories

The right accessories are important for
obtaining the correct position!



Head Supports

A wide range of head supports provide a large number of opportunities for individual support. Head supports maintain optimum head position and provide support in resting or active positions.

Highlights about Head support



On seating systems

The wide selection of head supports can easily be mounted on seating systems.



On wheelchairs

The wide selection of head supports can easily be mounted on wheelchairs.



On standing frames

The wide selection of head supports can easily be mounted on standing frames.



On bathing chairs

The wide selection of head supports can easily be mounted on bathing chairs.



Accessories



Head support

no.1 XX=01, no. 2 XX=03, no. 4 xx=06



Head support

no. 3 xx=05



Head support no. 7, flat

XX=13 no. 8, flat, XX=20



Anatomic head support

small XX=23, medium. XX=45, large XX=67



Adjustable head support

Two laterals XX=77



Adjustable head support

with four laterals XX=75



Anatomic head support

with headband X=5



Anatomic head support

no. 1, padded. XX=14



Adjustable head support

w/ (XX=71) or wo./speakers (XX=73)

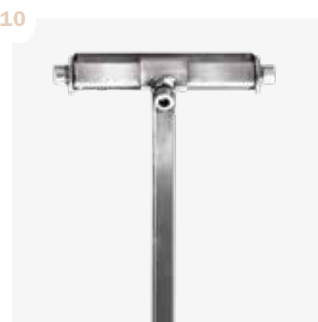

Stainless bar system

XX=48, XX=47

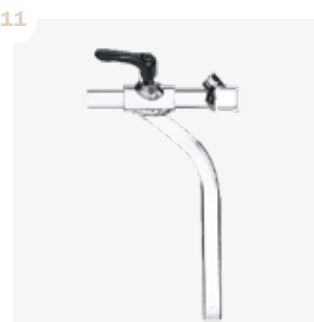

Swan neck bar system

XX=X1, XX=X2

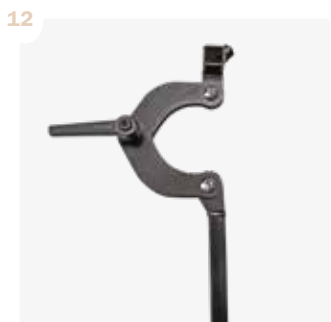

Turtle bar system

short xx=92, long xx=93

For more accessories - visit our website

13

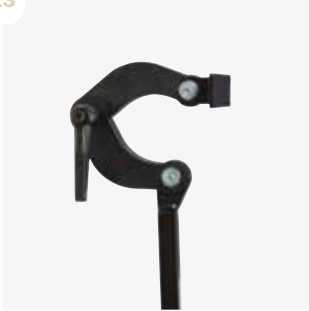

Turtle bar system, flat mount, long, short
xx=90, xx=91

14



I-2-1 bracket
87590

Head supports with different shapes and features to suit a wide range of needs.





Side Supports

R82 offers a wide range of side supports for seating aids to meet the needs of the individual user. Swing-away side supports are described here – for fixed side supports please see the specific product sections.

Highlights about side supports



For Wombat Living

The wide selection of side supports can easily be mounted on activity chairs.



For Flamingo

The wide selection of side supports can easily be mounted on bathing chairs.



For Panda Futura and x:panda

The wide selection of side supports can easily be mounted on seating systems.



For Cougar

The wide selection of side supports can easily be mounted on rehabilitation and comfort wheelchairs.



Accessories



Bars no. 10, 11, 15 and 16
XX=10 (12cm), XX=11 (16cm), XX=15 (Stainless 9,5cm), XX=16 (Stainless 16cm)



Bar no. 25,26 curved 25mm
xx=25 (length: 12cm)
xx=26 (length: 16cm)



Bar no. 45,46 curved 45 mm
XX=45 (length: 12cm)
XX=46 (length: 16cm)

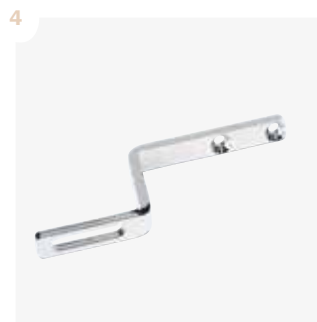

Bar no. 65,66 curved 65 mm
xx=65 (length: 12cm)
xx=66 (length: 16cm)



Different fittings
Fittings available in multiple shapes for multiple products
83Xxx-xxx



Cushion no. 1, 2 & 3 curved
X=1, X=2, X=3



Cushion no. 4 standard
X=4



Cushion no. 5 standard
X=5



Cushion no. 6 standard
X=6



PU colour
Black, grey and blue 83xxx-xxx
(Blue PU N/A in Australia)



Protection for side supports
black = 89150 grey = 89151



Belt for side support
84120-25 + 84120-40

For more accessories - visit our website

13

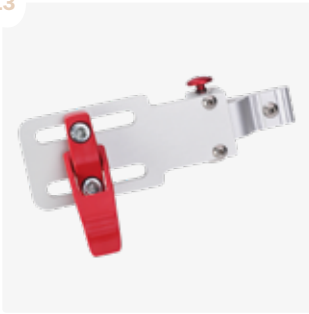

Snap lock

89102-30, 8910702-30

Fitting & Bars

Different fittings and bar side supports depending on the products.





Vests and belts

R82 has developed an extensive range of vests and belts to compliment seating and positioning systems. They increase comfort, safety, and ensure the correct sitting position.

Highlights about Vests and belts



Support at the hips

A wide selection of hip belts ensure the correct support for all users.



Support at the trunk

A wide selection of trunk supports ensure the correct support for all users.



Support at the feet

Different supports can be added for correct positioning of the user's feet.



Comfort and protection



Accessories



Shoulder straps
89663-H



Sternum belt
85430-x



Chest belt
85428-x



Neoprene vest
89113-x



Vest
89111-xxx



Cross vest
89625-xxx

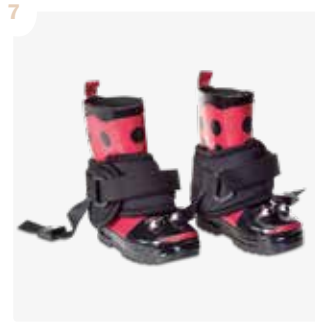

Ankle straps
85426-x



Belt harness neoprene
89114-x

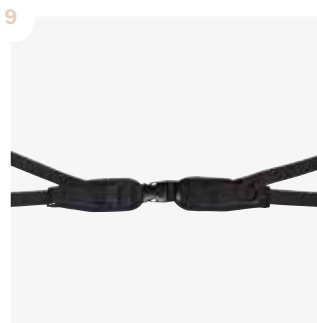

Y-hip strap upholstered
85427-x



Upholstered hip belt
85424-x



Neoprene hip belt
85423-x



Belt for transportation
85429-x

[For more accessories - visit our website](#)

13



Belt harness
89112-x

14

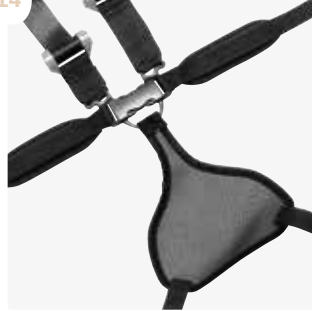

5-point belt
89665-x

15



Pelvis harness
89108-x

16



Hand wrist cuff
85425-x

17



Foot straps
85xxx

18



Neoprene sandals
85696-1

19



Thermo bag
87460-xxx

20



Rain cape with hood
87465-xxx

Still at eye level but with freedom of movement and secure support.





Trays

R82 provide a wide range of trays with different shapes, colours and materials. Trays with edges to keep toys etc. on the plate, while others are made without to provide more freedom of movement.

Highlights about Trays



Trays with edges

Trays with edges can be mounted on different seating systems.



Swing away trays

Option to choose a tray that can swingaway.



Transparent tray



Tray with transparent PC



Accessories



Tray with edge, shape 1
Grey ABS 89220-01/ Transparent PET
89230-01



Tray with edge, shape 2
Wood 89200-2/Grey ABS 89220-2/
PET 89230-2



Tray with edge, shape 3
Grey ABS 89220-3/ Transparent PET
89230-3



Tray with edge, shape 5
Grey ABS, 8910720-1/Single rod 8910725-1



Tray with edge, shape 6
Grey ABS 8910720-2, 8910725-2/
8910725-5



Tray with edge, shape 7
Grey ABS 8910725-3



Tray with edge, shape 8
Available in grey ABS



Tray without edge, shape 4
Transparent PS 970240-x, 9512x



Tray without edge, shape 5
Transparent PS 970260-1 and 970260-2



Tray without edge, shape 6
Transparent PC 87200x0



Toy bar for tray
8910740



Grip handle for tray
8910750

For more accessories - visit our website

13



Arm rest for tray
8910730

Bertram, 2 years old

"It is easier to reach my toys"



Find us...

R82 A/S
 Parallelvej 3
 8751 Gedved
 Denmark
 Tel +45 79 68 58 88
 Fax +45 75 66 51 92
 R82@R82.com
 R82.org
 Facebook.com/R82global

Etac | R82 Ltd
 Unit D4A
 Coombswood Business Park
 East Coombswood Way, Halesowen
 West Midlands
 B62 8BH
 Great Britain
 Tel +44 (0)121 561 2222
 Fax +44 (0)121 559 5437
 R82uk@R82.com
 R82.co.uk
 facebook.com/R82UK

Etac | R82 GmbH
 Industriestraße 13
 45699 Herten
 Germany
 Tel. +49(0)2366 500 60
 Fax +49(0)2366 500 6282
 r82@etac.de
 R82.de
 facebook.com/R82.de

Etac | R82 Nederland B.V.
 Tinweg 8
 8445 PD Heerenveen
 The Netherlands
 Tel +31 (0)513 68 16 86
 Fax +31 (0)513 68 19 84
 R82nl@R82.com
 R82.nl
 R82.be
 fr.R82.be

Supplier for:
 Rest of the world

Supplier for:
 United Kingdom, Ireland

Supplier for:
 Germany, Luxembourg, Austria,
 Switzerland

Supplier for:
 The Netherlands

Convoid Products, LLC
 2830 California Street
 Torrance, CA 90503
 USA
 Tel 844-US-Mobility (844-876-6245)
 Convoid-R82.com
 facebook.com/ConvoidR82Kids

R82 Inc.
 12801 E. Independence Blvd.
 Matthews, NC 28106
 USA
 Tel 844-US-Mobility (844-876-6245)
 Convoid-R82.com
 facebook.com/ConvoidR82Kids

R82 au Pty Limited
 PO Box 284
 Botany NSW 1455
 Australia
 Tel +61 (02) 8213 6666
 Fax +61 (02) 8213 6655
 R82.com.au
 facebook.com/R82Australia
 au.sales@r82.com

Etac | R82 srl
 Via Stalingrado 71/7h
 40128 Bologna
 Italy
 Tel +39 051 2819228
 Fax +39 05119873816
 Italia.info@r82.com
 www.R82.it

Supplier for:
 USA, Canada

Supplier for:
 USA, Canada

Supplier for:
 Australia

Supplier for:
 Italy



Sales Companies
 Distributors



Abreast of the future

As the name suggests, R82 was founded in 1982. Since those early pioneering days in the rehabilitation sector, R82 has created simple and user-friendly technical aids and appliances for disabled children and young people.

Flexibility and adaptation to the needs of the individual user were at the heart of the founding of R82 and still is.

Thanks to the consistent philosophy of constant development and high-tech production in a healthy working environment, R82 remains a vibrant, dynamic and growing company.

With a well-designed and high quality range of products in all areas of the technical aid and appliance business, R82 constantly keeps abreast of the future – to the benefit of both users and helpers.



R82 UK Ltd.

Unit D4A
Coombswood Business Park
East Coombswood Way
Halesowen
West Midlands B62 8BH
Great Britain
Tel 0121 561 2222
Fax 0121 559 5437
R82uk@R82.com
R82.co.uk
facebook.com/R82UK